

INSTEON[®] Thermostat

Owner's Manual (#2441TH, 2732-422, 2732-522)

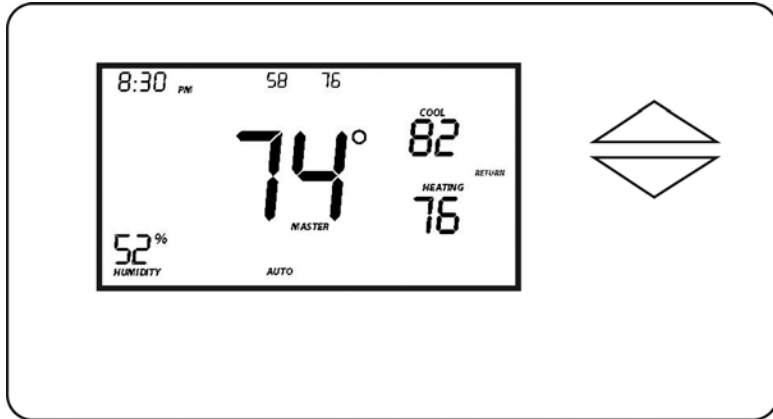
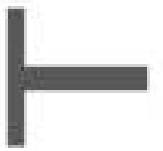

| | |
|--|-----------|
| About INSTEON Thermostat | 3 |
| INSTEON Thermostat – Features and Benefits | 3 |
| What's in the Box? | 3 |
| INSTEON Thermostat Button Overview | 4 |
| INSTEON Thermostat Operation and Programming | 5 |
| Mode Button Operation | 5 |
| Energy Button Operation | 6 |
| Set Button Operation | 7 |
| Time/Sensor Button Operations | 7 |
| Program Button Operation | 8 |
| Fan and Hold Button Operations | 10 |
| Master Button Operation | 10 |
| Installation | 11 |
| Tools Needed | 11 |
| Installation | 11 |
| Wire Connections | 12 |
| Test Operation | 13 |
| Adding an INSTEON Wireless Thermostat | 13 |
| INSTEON Programming | 14 |
| Add INSTEON Thermostat as an INSTEON Controller | 14 |
| Removing INSTEON Thermostat as an INSTEON Controller | 16 |
| Add INSTEON Thermostat as an INSTEON Responder | 17 |
| Remove INSTEON Thermostat as an INSTEON Responder | 17 |
| User Setup Mode Overview | 19 |
| User Setup Mode | 19 |
| Temperature and Humidity Calibration Mode | 21 |
| Advanced 2-Stage Heating or Cooling Systems | 22 |
| Factory Reset | 22 |
| Specifications | 23 |
| Troubleshooting | 25 |
| DECLARATION OF CONFORMITY | 26 |
| Certification and Warranty | 28 |
| Limited Warranty | 28 |
| Limitations | 28 |

About INSTEON Thermostat

INSTEON Thermostat is a 7-day programmable INSTEON-compatible thermostat. INSTEON Thermostat includes a humidity sensor and 2-stage heating plus 2-stage cooling capabilities.

Expand the system by creating extra temperature zones in your home. Simply add one or more INSTEON Wireless Thermostats as accessories to your system. Additionally, a Waterproof Temperature Sensor can be added and extended up to 100 feet for remote temperature sensing.

INSTEON Thermostat – Features and Benefits

- Installs and joins scenes with other INSTEON devices in minutes
- Saves energy and money by remotely controlling and automating your home's heating and AC
- Communicates wirelessly over radio frequency (RF)
- Can automatically remotely control INSTEON devices when INSTEON Thermostat reaches a specified temperature or humidity level or switches to A/C or heat
- Reports changes in thermostat modes, temperature, humidity, setpoints and fan to compatible automation controllers or software
- Fine-tunes thermostat setpoints by single degrees from any INSTEON controller with specific Up and Down buttons
- Stores setup state in memory so settings aren't lost during power outages
- Two-year warranty
- Controllable via the web and smartphone app (iOS/Android) using SmartLinc™ controller or INSTEON Hub

What's in the Box?

- INSTEON Thermostat
- Two mounting screws
- Two anchors
- Quick Start Guide
- Wire ID label stickers

INSTEON Thermostat Button Overview

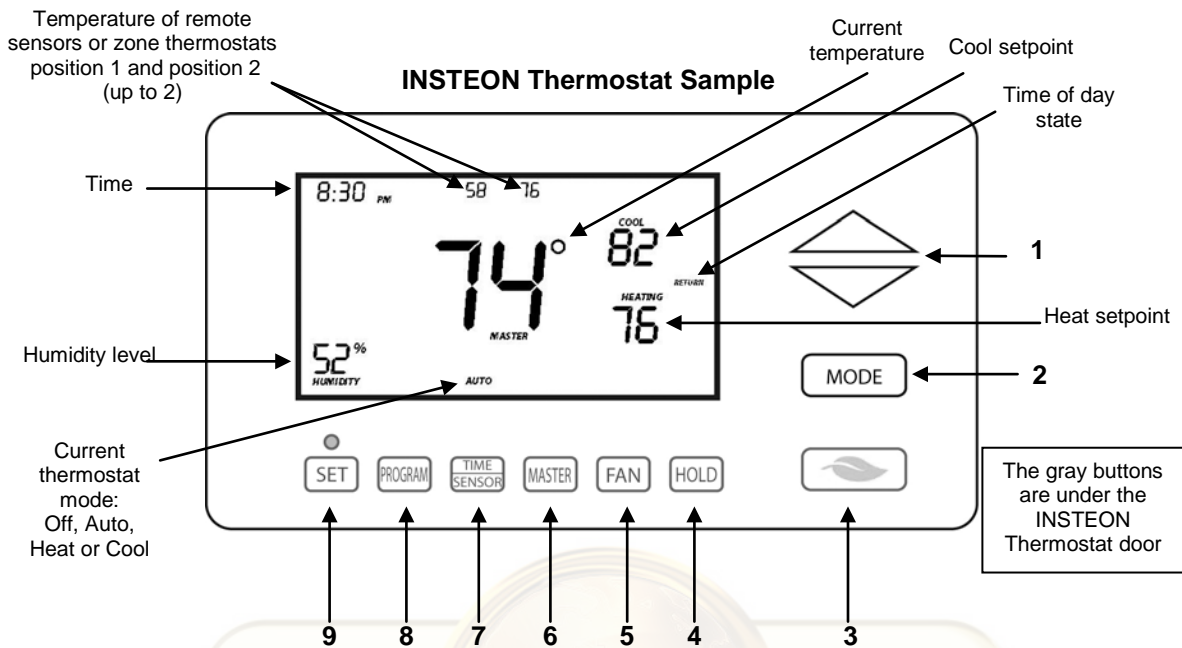

- 1) **Up/Down** buttons adjust the temperature setpoint based on the current mode.
- 2) **Mode** allows the user to select the current operational mode of the HVAC system. It cycles among Off, Heat, Cool, Auto and Time of Day.
- 3) **Energy (Leaf)** button is designed as a quick access option that saves energy (and money). When pressed, it will set back the setpoint by a specified value. The default value is 4° from the current setting. To change the default offset value you must use software such as HouseLinc™.
- 4) **Hold** overrides a preprogrammed mode to stay in the current settings mode.
- 5) **Fan** cycles between Auto and Always On – there is no indicator for Auto Fan.
- 6) **Master** makes this device the master temperature controller when you have one or more zone thermostats. Pressing and holding “Master” does not alter any scene or screen settings; it just defines this INSTEON Thermostat as the master temperature controller.
- 7) **Time/Sensor** allows you to set the day and time. It cycles among hour, minute, day and time programming.
- 8) **Program** allows you to set up the various preprogrammed modes (Wake, Leave, Return and Sleep). It also allows you to setup various features and calibrate the temperature and humidity.
- 9) **Set** is for adding and removing INSTEON Thermostat to and from INSTEON scenes. It functions like the Set button on other INSTEON devices.

INSTEON Thermostat Operation and Programming

Mode Button Operation

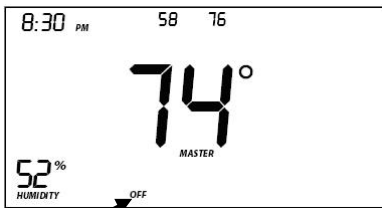

Off Mode:

- No setpoints are shown.
- Up/Down arrows do not do anything.

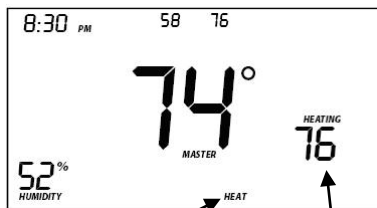

Heat Mode:

- Only Heat setpoint is shown.
- Up/Down arrows change Heat setpoint.

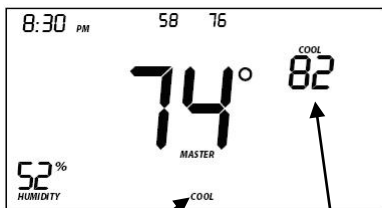

Cool Mode:

- Only Cool setpoint is shown.
- Up/Down arrows change Cool setpoint.

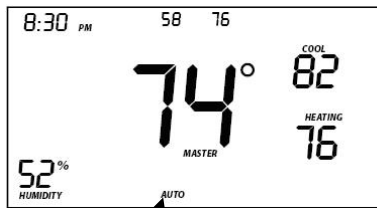

Auto Mode:

- Both Cool and Heat setpoints are shown.
- Up/Down arrows increase or decrease values by the same amount.

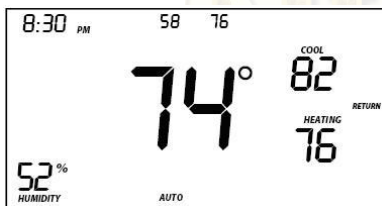

Time of Day Mode:

- The program mode is active as indicated by the return annotation.
- The Time of Day annotation is not displayed in the other four modes (Off, Heat, Cool or Auto).
- Both Cool and Heat setpoints are shown.
- Up/Down arrows increase or decrease values by the same amount.
- When the thermostat moves to the next time period, the setpoints will be adjusted accordingly.

Note:

- To adjust the gap between the setpoints in Auto mode, press Mode to select Heat and set the temperature you desire. Press Mode to select Cool and set the temperature you desire. Press Mode to return to Auto; the settings will reflect your changes.
- If you set Heat and Cool to the same temperature, Heat will automatically move down 2° (the minimum allowable gap).

Energy Button Operation

The Energy button is designed to be a quick, efficient energy-saving option. When you press the Energy (leaf) button, INSTEON Thermostat will adjust the Heat and Cool setpoints by a specified value. The default value is 4° from the current setting. The default value can be changed via software such as HouseLinc.

- When you exit Energy mode, it will revert back the 4° that was changed upon entry.
- The unit remains in Energy mode until the Energy button is pressed again.
- Up/Down arrows adjust the temperature setpoint based on the mode you are in.

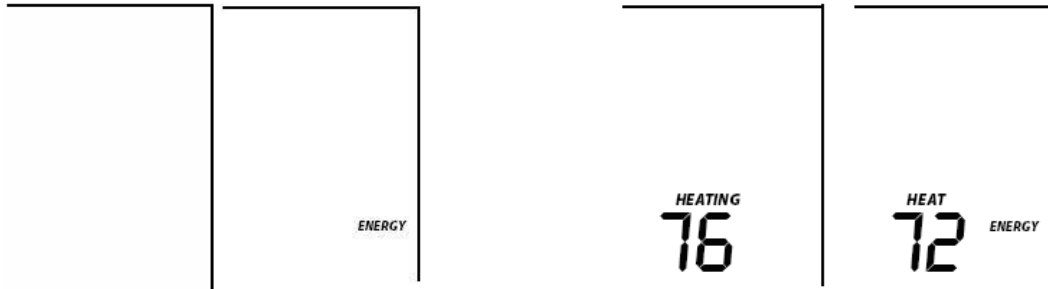

From Off Mode:

- Energy button does nothing because the system is off (at maximum energy savings already).
- When “Energy” appears on the screen for Auto, Cool and Heat Modes, the 4° setback is engaged.

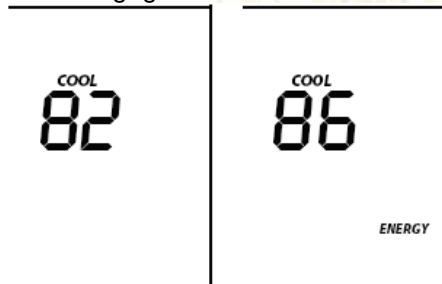

From Heat Mode:

- Heat setback as specified.
- Default setback is 4° less.
- Notice that “Heating” is active on the left, but not on the right since the setpoint is lower than the actual temperature; the element reads “Heat.”

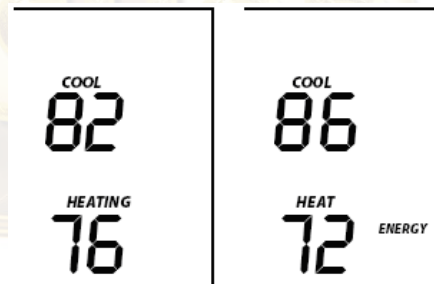

From Cool Mode:

- Cool setback as specified.
- Default setback is 4° more.

From Auto Mode:

- Both Heat and Cool setpoints changed as specified.
- Default setback is 4° more for Cooling and 4° less for Heating.
- Notice that “Heating” is active on the left, but not on the right since the setpoint is lower than the actual temperature; the element reads “Heat.”

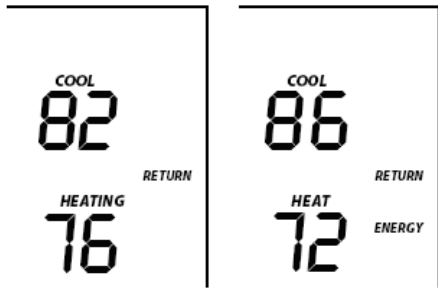

From Time of Day Mode:

- Both Heat and Cool setpoints changed as specified.
- Default setback is 4°.
- Notice that “Heating” is active on the left, but not on the right since the setpoint is lower than the current temperature; the element reads “Heat.”

Note: Onscreen text displaying “Heat” changes to “Heating” and “Cool” changes to “Cooling” to indicate HVAC system is active. The status LED, if enabled, under the door also indicates current active state: Cooling = green, Heating = red. At time of activation either Heating or Cooling text will blink for 3 seconds then remain steady during the active cycle.

Set Button Operation

The Set button adds and removes INSTEON Thermostat from INSTEON scenes. It functions like the Set button on other INSTEON devices.

Time/Sensor Button Operations

- The Time/Sensor button allows the user to set the current day and time.
- It cycles among hour, minute, day and 12/24-hour format.
- Up/Down arrows cycle through the available options.
- Go to the next Time/Sensor step by pressing Time/Sensor button again.
- Exit Time/Sensor setup by:
 - Timing out (4 minutes)
 - Pressing Mode button

Note: Colored elements indicate LCD element that should be blinking during setting procedure.

First press of Time/Sensor:

Hours settings

- Up/Down arrows cycle through time in 1-hour increments.
- Pressing and holding Up/Down arrows cycles through faster.

Note: AM/PM changes automatically as needed.



Second press of Time/Sensor:

Minutes settings

- Up/Down arrows cycle through time in 1-minute increments.
- Pressing and holding Up/Down arrows cycles through faster.



Third press of Time/Sensor:

Day settings

- Up/Down arrows cycle through each day of the week as shown.



Fourth press of Time/Sensor:

Clock Format setting (12- or 24-Hour clock)

- Entire "time" blinks.
- Up/Down arrows cycle between 12- and 24-hour clock format.

Note: AM/PM is not displayed when in 24-Hour format.



Press Time/Sensor a fifth time to exit.

Program Button Operation

- The Program button allows you to set up the various preprogrammed modes (Wake, Leave, Return and Sleep).
- Go to the next step by pressing Program again.
- Exit Program setup by:
 - Timing out (4 minutes)
 - Pressing Mode button

Note: Colored text below indicate element that should be blinking during setting procedure.

First press of Program:

Selects from available pre-program modes

Up/Down arrows cycle through Wake, Leave, Return and Sleep.

NOTE:

- Energy is not a part of this option.
- Once a preprogrammed mode is selected, that item remains displayed throughout to indicate the mode you are programming.
- The current mode settings are displayed on the thermostat at each setup step.



Second press of Program:

Day setting

- Up/Down buttons cycle among all week, weekdays, weekend days and each day, as shown.



Third press of Program:

Start Time

- Up/Down arrows cycle through time in 15-minute increments. *Note: when pressing the Down arrow, if you come within 15 minutes of another preprogrammed mode time, you will not be able to increase the time any further.*
- Pressing and holding Up/Down arrows cycles faster.

Note: AM/PM changes automatically as needed.



Note: The start of one program mode is also the end of the previous program mode.

Fourth press of Program:

Cool setpoint

- Up/Down arrows cycle through temperature.



Fifth press of Program:

Heat setpoint

- Up/Down arrows cycle through temperature.

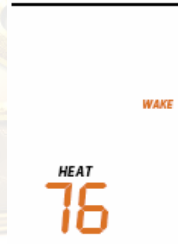

Sixth press of Program:

- Restarts the process to program another Mode/Day

NOTE: The four modes come preprogrammed. The defaults are for all days:

| Day Modes | Start Time | Thermostat Mode | Heat Setting | Cool Setting |
|-----------|------------|-----------------|--------------|--------------|
| Wake | 6:00AM | Auto | 65°F (18°C) | 75°F (24°C) |
| Leave | 8:30AM | Auto | 60°F (16°C) | 80°F (27°C) |
| Return | 5:00PM | Auto | 65°F (18°C) | 75°F (24°C) |
| Sleep | 11:00PM | Auto | 60°F (16°C) | 80°F (27°C) |

Fan and Hold Button Operations

Fan button operations

- The Fan button cycles between Auto and Always On.
- On the display, it simply indicates the text “Fan Always” when selected. There is no indication for Fan Auto.

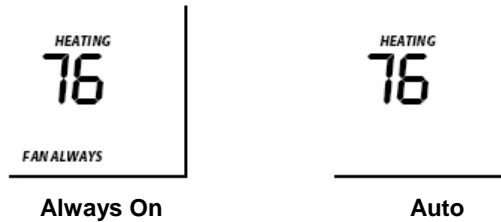

Hold button operations

- The Hold button overrides a preprogrammed mode until Hold is turned off.

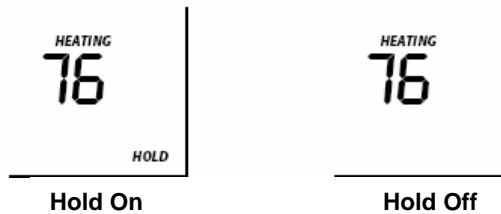

NOTE:

- While Hold is enabled, the next preprogrammed time that comes in Time of Day Mode will be ignored.
- While Hold is enabled, the preprogrammed time notations are not shown (i.e. Wake, Leave, Return and Sleep).
- Hold can be remotely enabled/disabled from an INSTEON controller.

Master Button Operation

First press and hold:

Makes the local INSTEON Thermostat the master temperature controller

- To perform this, press and hold Master button for 3 seconds.
INSTEON Thermostat beeps once.
- Release.

Note: This is only valid if at least one INSTEON Thermostat Zone Thermostat is linked to INSTEON Thermostat.

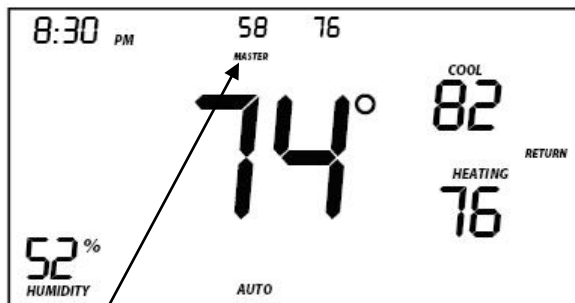

Before pressing Master button:

- Notice that the left remote sensor is currently the Master temperature controller.

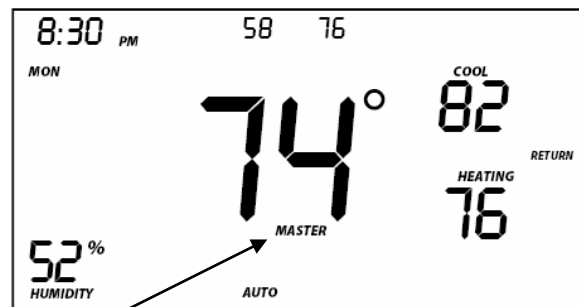

After pressing and holding Master button:

- Notice that the left remote sensor is no longer the Master temperature controller.
- The local INSTEON Thermostat is now the Master controlling temperature.

Note: If no INSTEON scene is programmed to a INSTEON Wireless Thermostat, pressing and holding for 3 seconds will cause the Master segment to display while the button is being held.

Installation

CAUTIONS AND WARNINGS

Read and understand these instructions before installing and retain them for future reference.

IMPORTANT: HOW DO I KNOW THIS WILL WORK WITH MY SYSTEM?

- 1) Your existing HVAC can operate 2 stages of Heat and Cool.
- 2) Your existing thermostat operates on 24V.
- 3) Your system is not a heat pump.
- 4) Your system is not a 120/240V electric radiant heater.
- 5) Your existing thermostat is not millivolt controlled.
- 6) Your existing thermostat has 5 or more wires connected.

INSTEON Thermostat is designed to operate on a minimum 5-wire, 24V HVAC unit. If you have only 4 wires you can purchase the "Add-A-Wire" adapter item #304AAW from www.smarthome.com.

Note: Installation should be performed only by a qualified HVAC Technician or a homeowner who is familiar and comfortable with electrical circuitry. If you have any questions regarding installation, consult an HVAC Technician or call the INSTEON Support Line at 800-762-7845.

Tools Needed

- Flathead screwdriver
- Wire cutter/stripper

Installation

Proper installation of the INSTEON Thermostat will be accomplished by following these step-by-step instructions

- 1) **Do not remove wires from existing thermostat until instructed.**
- 2) If you have A/C, turn off A/C breaker.
 - a. Confirm A/C is off by turning on air and observing that compressor/fan do not come on.
- 3) Turn off breaker/fuse to furnace.
 - a. If thermostat no longer functions, move to next step.
 - b. If thermostat still functions, it is probably running off battery power. Try to turn on heat.
 - i. If heat doesn't turn on, move to next step.
 - ii. Otherwise, turn off heat and wait until furnace fan stops, then try another breaker until heat no longer runs.
- 4) Remove cover from existing thermostat to gain access to wires (may need to detach from wall).
- 5) If necessary, take photo of wiring connections to help with reconnections.
- 6) If possible while still connected, attach the "C" label to the wire connected to "C" on your thermostat. Otherwise, label C wire once disconnected.
- 7) Disconnect your C wire from thermostat.
- 8) Repeat for all your other wires, being careful to not pull off wire stickers or mar paint or wallpaper.
- 9) Remove existing thermostat back from wall.
- 10) Remove 3" of the outer jacket from the wires exposing the individually colored wires. This ensures the outer insulation does not press against the internal components of the INSTEON Thermostat upon closing the unit. *Note: if your system has 4 wires, you will need the "Add-a-Wire" adapter. See Cautions and Warnings above.)*
 - a. Be careful not to tear off the labels that you previously attached to the wire ends.
 - b. If you do not have 3" after stripping away the outer jacket, you can extend the inner wires by splicing on a new longer conductor.
 - i. "Thermostat" cabling is available at most home improvement centers. It comes in different wire configurations, but the same gauge. If the wire you have now is 5-conductor cable, buy 5-conductor thermostat wire and connect it matching color-to-color.
 - c. If wires are longer than 3", trim them back or make sure you can push the excess back into the wall. Be careful not to cut off the wire designation label.
- 11) Slide all wires through large hole in back of INSTEON Thermostat.
- 12) Mount INSTEON Thermostat to wall.

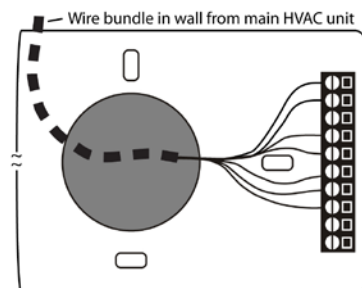

- 13) **To ensure accurate temperature readings:**
 - a. Carefully slide wires through provided black grommet (draft shield). See diagram.
 - b. Peel off protective backing.
 - c. Rotate to most convenient orientation for wire entrance.
- 14) Apply to round grommet placing indentation.

Wire Connections

If the terminal designations on your old thermostat do not match those on INSTEON Thermostat, refer to the chart below or the wiring diagram that follows:

| Wire color from furnace/AC unit Wire colors may vary | Function | Install on INSTEON Thermostat connector |
|---|------------|---|
| Black or blue | Common 24V | 24V COM |
| Red | Power 24V | 24 RH |
| White | Heat 1 | W1 |
| Brown | Heat 2 | W2 |
| Green | Fan | G |
| Yellow | Cooling 1 | Y1 |
| Light blue | Cooling 2 | Y2 |

Diagram below shows inside of INSTEON Thermostat wall mount case:

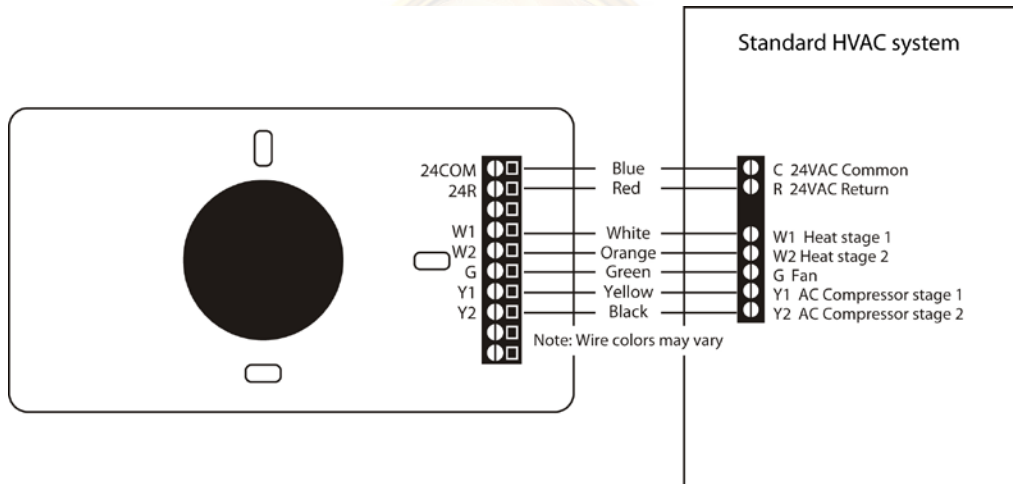

- 15) Insert C wire into terminal C and tighten using small screwdriver (either flathead or Philips).
 - a. Be aware that incorrect connections may cause non-operation or Heat, Cool and Fan to be wrongly triggered.
- 16) Repeat for other wires matching terminal designations.
- 17) Close front of INSTEON Thermostat onto back mounting plate.
 - a. Press firmly until you feel the connecting pins fully seat into their receptacles. You should also feel and hear a click as the door latches.
- 18) Turn breaker(s) back on.
- 19) Allow 10 seconds for INSTEON Thermostat to boot up.
When screen displays current temperature, INSTEON Thermostat is powered and functional.

Test Operation

Heating Mode Test

- 1) Press Mode once to enter Heat mode.
- 2) Tap the Up arrow several times until setpoint is 2° above current temperature.
*INSTEON Thermostat will call for heat and "Heat" segment will change to "Heating."
"Heating" segment will flash for 3 seconds, then remain steady when active.
Status LED will display red if enabled (off by default).
Allow furnace to operate long enough to begin blowing warm air.*
- 3) Tap the Up or Down arrows until you reach a desirable heat temperature setpoint (if this is below ambient, Heating will go inactive).
Note: Fan stays controlled by HVAC and may continue running for a couple minutes. INSTEON Thermostat has a default 5-minute delay between Heat and Cool settings.

Cooling Mode Test

- 1) Tap Mode button again to enter Cool mode.
- 2) Tap the Down arrow several times until setpoint is 2° below current temperature.
*INSTEON Thermostat will call for cooling and "Cool" segment will change to "Cooling."
"Cooling" segment will flash for 3 seconds, then remain steady when active.
Status LED will display green.
Allow A/C to operate long enough to begin blowing cool air.*
- 3) Tap the Up or Down arrows until you reach a desirable cool temperature setpoint (if above ambient, Cooling will go inactive).
Note: Fan will turn on and off with Cooling.

Auto Mode Test

- 1) Tap Mode once to enter Auto mode.
- 2) Note that your Heat and Cool setpoints are both as set in previous steps, unless you did not have a minimum 2° gap between settings.
- 3) Tap Up arrow once to increase both Heat and Cool setpoints by 1°.
- 4) Tap Down arrow once to decrease both Heat and Cool setpoints by 1°.
- 5) Tap Mode once to enter Time of Day mode.
Indicated by Auto at bottom and relevant time of day (Wake, Leave, Return, Sleep) to right of Heat/Cool set temps.
- 6) Tap Mode once more to return to Off mode.

Adding an INSTEON Wireless Thermostat

INSTEON Thermostat can synchronize with a INSTEON Wireless Thermostat to provide a portable thermostat wherever you want temperature control. You can add up to two INSTEON Wireless Thermostats.

- 1) Press and hold Set button on INSTEON Wireless Thermostat.
INSTEON Wireless Thermostat Set LED will blink green and unit will beep.
- 2) Press and hold INSTEON Thermostat Set button.
*INSTEON Thermostat will beep, then double-beep.
INSTEON Wireless Thermostat will double-beep.*
- 3) Test the scene by pressing and holding the Master button on the INSTEON Thermostat.
 - When properly added, pressing the Master button on the INSTEON Thermostat will illuminate the "Master" segment on that same screen. Additionally, the present room temperature of the INSTEON Wireless Thermostat will be displayed in position 1 as the small temperature segments at top center of the display.
 - A visual inspection of each display will reveal the Master status of each INSTEON Thermostat or Zone Thermostat.

Note: Only the INSTEON Thermostat is directly connected to the HVAC system via wires. If you plan on operating multiple INSTEON Wireless Thermostats you must have at least one INSTEON Thermostat to control the HVAC.

INSTEON Programming

Add INSTEON Thermostat as an INSTEON Controller

INSTEON Thermostat can be set up to control other INSTEON devices or trigger software events when there is a change. The following INSTEON Thermostat changes can be configured as a controller:

- Group 1 - Cooling mode change (scene control)
- Group 2 - Heating mode change (scene control)
- Group 3 - Dehumidification, high humidity setpoint (scene control)
- Group 4 - Humidification, low humidity setpoint (scene control)
- Group EF - Broadcast on any change (notification group for linked software controllers)¹

NOTE: An INSTEON Wireless Thermostat can also be added to a scene as a controller to Groups 1 - 4. When it is added as a controller of a INSTEON Thermostat, the setpoints between INSTEON Wireless Thermostat and INSTEON Thermostat will always be matched. When it is not added as a controller to a INSTEON Thermostat, the setpoints are local only. INSTEON Wireless Thermostat will send group commands based on local temperature or humidity level and the setpoint shown on the display, regardless of whether it's added as a controller to a INSTEON Thermostat.

Note: Humidity levels are taken from the local device only; they are not shared or matched among thermostats.

- 1) Press and hold INSTEON Thermostat's Set button until it beeps.
INSTEON Thermostat will beep.
INSTEON Thermostat Set LED will blink green.
- 2) Tap Up or Down arrows to select from Groups 1-4 to add to a scene.
 - Group 1 – Cooling mode change (default)
 - Group 2 – Heating mode change
 - Group 3 – Dehumidification, high humidity setpoint
 - Group 4 – Humidification, low humidity setpoint
- 3) Adjust scene responder (such as OutletLinc with connected humidifier) to the state you want when scene is activated (e.g., 50%, 25% or even Off).²
- 4) Press and hold responder's Set button until it double-beeps or its LED flashes.
INSTEON Thermostat will double-beep upon completion.
LED will return to previous state.
- 5) Confirm scene addition was successful by raising or lowering INSTEON Thermostat's setpoint to activate the particular mode.
After INSTEON Thermostat changes to active mode set in step 2 above, responder will toggle between the scene's on-level and off.
- 6) To add more responders to the scene, repeat steps 1-5 for each additional responder.

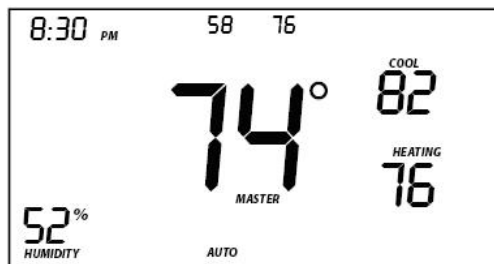

Upon entering scene mode, this screen will display for ~ 2 seconds.

¹ Group FE is a hexadecimal representation of Group 254 and can only be configured using software.

² If the responder is a multi-scene device such as a KeypadLinc, tap the scene button you wish to control until its LED is in the desired scene state (on or off).

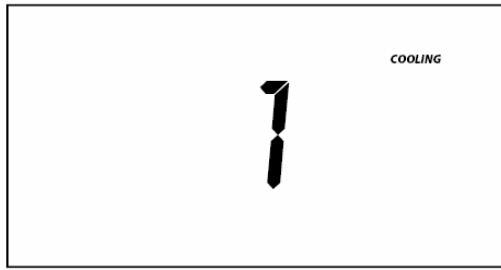

LCD display after 2 seconds.

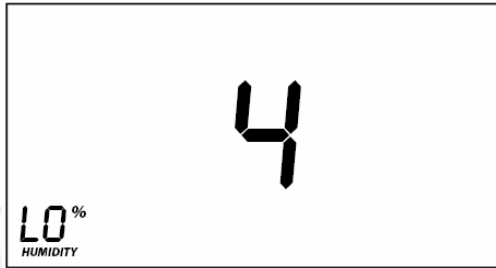
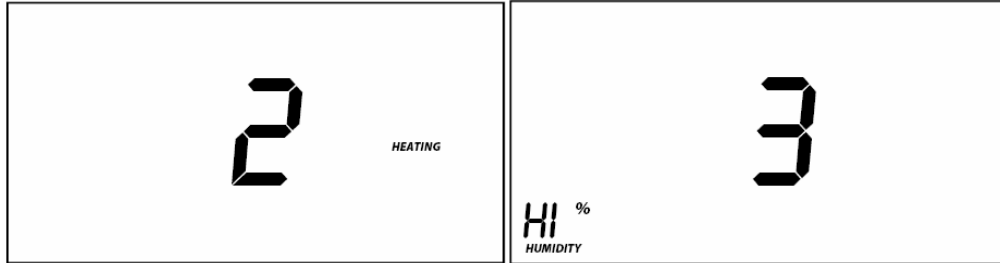

LCD display when using Up or Down arrows to select from the 4 controller groups.

Removing INSTEON Thermostat as an INSTEON Controller

If you want to remove INSTEON Thermostat from a scene as a controller, follow instructions below. Whenever possible, use software for managing scene memberships.

Note: If you choose to remove INSTEON Thermostat from use, it is important that you remove scene memberships from all responders. Follow the instructions below for each responder of which INSTEON Thermostat is a member.

- 1) Press and hold INSTEON Thermostat's Set button until it beeps.
INSTEON Thermostat Set LED will blink green.
INSTEON Thermostat will beep.
- 2) Press and hold INSTEON Thermostat's Set button again to put it in scene mode.
INSTEON Thermostat Set LED will blink red.
INSTEON Thermostat will beep.
LCD display indicates the group from which you are removing the scene.
- 3) Tap Up and Down arrows to select appropriate group to remove from:
 - Group 1 - Cooling mode change, default
 - Group 2 - Heating mode change
 - Group 3 - Dehumidification, high humidity setpoint
 - Group 4 - Humidification, low humidity setpoint
- 4) Press and hold responder's Set button.
INSTEON Thermostat will double-beep upon completion.
LED will return to previous state.

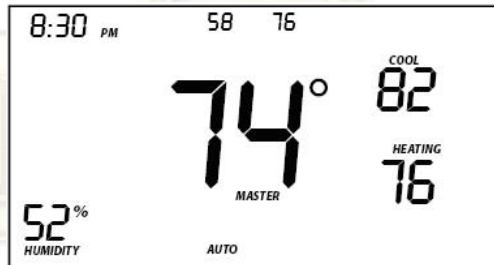

Upon entering Add to a Scene mode.

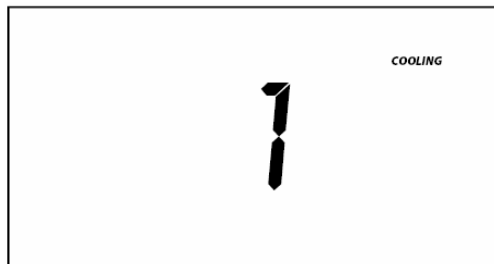

Upon entering Remove from a Scene mode (defaults to Cooling mode).

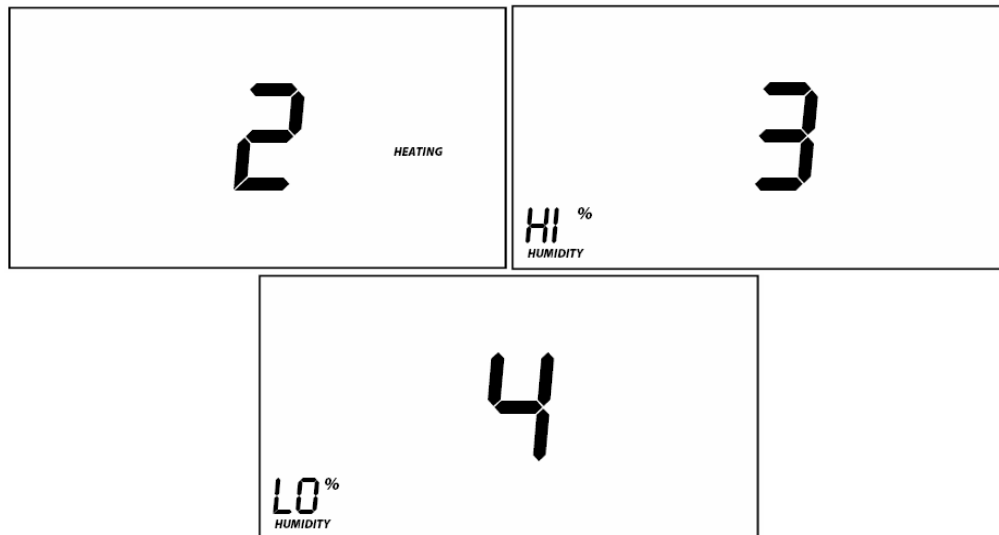

LCD display when using Up or Down arrows to select from the 4 controller Groups.

Add INSTEON Thermostat as an INSTEON Responder

Add a scene to an incoming ON command

- 1) Set INSTEON Thermostat to desired state (mode, setpoint, fan state, energy button state).
- 2) Put controller in linking mode (press and hold controller Set button until it beeps).
- 3) Press and hold INSTEON Thermostat's Set button.
INSTEON Thermostat Set LED will blink green and unit will beep.
INSTEON Thermostat will double-beep.
LED will return to previous state.

Add a scene to an incoming OFF command

- 1) Set INSTEON Thermostat to desired state.
- 2) Put controller in linking mode (press and hold controller Set button).
- 3) Simultaneously press and hold INSTEON Thermostat's Set button and Down arrow.
INSTEON Thermostat Set LED will blink green and unit will beep.
INSTEON Thermostat will double-beep.
LED will return to previous state.

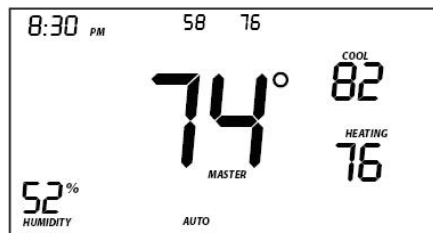

Display while in Add to a Scene Mode to ON or OFF

Remove INSTEON Thermostat as an INSTEON Responder

If you want to remove INSTEON Thermostat from a scene, follow instructions below. Whenever possible, use software for managing scene memberships.

Note: If you choose to remove INSTEON Thermostat from use, it is important that you remove scene memberships from all controllers. Otherwise, controllers will retry commands repetitively, creating network delays. Follow the instructions below for each scene controller of which INSTEON Thermostat is a member.

Removing a scene from an incoming ON command

- 1) Press and hold controller's scene button until controller beeps.¹
Controller's LED will blink.
- 2) Press and hold controller's scene button again until controller beeps again.
Controller's LED will continue blinking.
- 3) Press and hold INSTEON Thermostat's Set button.
INSTEON Thermostat Set LED will blink green and unit will beep.
INSTEON Thermostat will double-beep.
LED will return to previous state.
Controller's LED will stop blinking.
- 3) Confirm scene removal was successful by tapping the controller scene button you just removed.
INSTEON Thermostat will no longer respond.

Removing a scene from an incoming OFF command

- 1) Press and hold controller's scene button until controller beeps.
Controller's LED will blink.
- 2) Press and hold controller's scene button until controller beeps again
Controller's LED will continue blinking.
- 3) Simultaneously press and hold INSTEON Thermostat's Set button and Down arrow.
INSTEON Thermostat Set LED will blink green and unit will beep.
INSTEON Thermostat will double-beep.
LED will return to previous state.
Controller's LED will stop blinking.
- 4) Confirm scene removal was successful by tapping the controller scene button you just removed.
INSTEON Thermostat will no longer respond.



¹ For devices without beepers hold until its LED begins blinking (this may take 10+ seconds)

User Setup Mode Overview

Press and hold Program button for 3 seconds or more to enter the User Setup Mode.

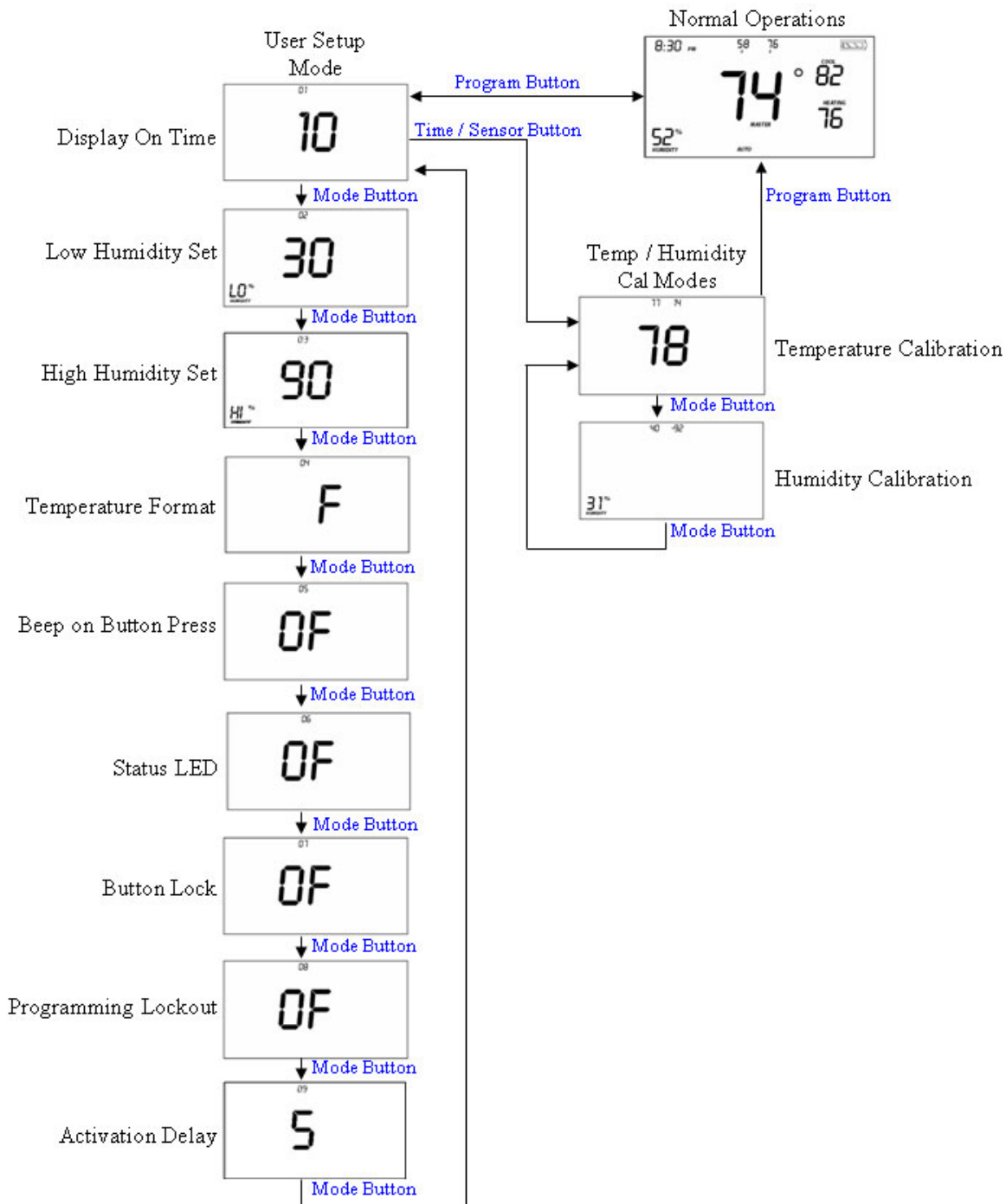

User Setup Mode

- 1) Press and hold Program button to access the following options:
 - Press Mode to step between menu items (sub-mode number will appear on top of the screen).
 - Sub-mode 01: Display LED on-time select (default is 10 seconds)
 - Sub-mode 02: Humidity low setpoint (default is 30%)

- Sub-mode 03: Humidity high setpoint (default is 90%)
- Sub-mode 04: Temperature format select (default is Fahrenheit)
- Sub-mode 05: Beep on button press (default is Off)
- Sub-mode 06: Status LED (default is Off)
- Sub-mode 07: Button lock (default is Off)
- Sub-mode 08: Programming lock (default is Off)
- Sub-mode 09: Activation delay (default is 5 minutes)

Press the Up or Down arrow to change a setting.

- Sub-mode 01: LED backlight ON time (10-second default)
 - a. Tap Up or Down arrow to step between Off, 10 sec, 60 sec and On
 - b. Use HouseLinc software to set the LED backlight ON-time in 1-second intervals



- Sub-mode 02: Humidity low setpoint (humidification, 30% default)
 - a. Up arrow = Increase humidity % setpoint
 - b. Down arrow = Decrease humidity % setpoint
 - c. Range = 0 to 79%



- Sub-mode 03: Humidity high setpoint (dehumidification, 90% default)
 - a. Up arrow = Increase humidity % setpoint
 - b. Down arrow = Decrease humidity % setpoint
 - c. Range = 20 to 90%



- Sub- mode 04: Temperature format select (C or F, F default)
 - a. Up arrow = C
 - b. Down arrow = F



- Sub-mode 05: Beep on button press (enable/disable, OFF default)
 - a. Up arrow = ON
 - b. Down arrow = OFF



- Sub- mode 06: Status LED (enable/disable, OFF default)
 - a. Up arrow = ON
 - b. Down arrow = OFF



Sub- mode 07: Button lock (disables front button presses, OFF default)

- For high-traffic common area locations, such as a business lobby.

- a. Up arrow = ON
- b. Down arrow = OFF



- Sub- mode 08: Programming lock (locks out Set button programming operations, OFF default)

- a. Up arrow = ON
- b. Down arrow = OFF



- Sub- mode 09: Delay between consecutive AC modes (5-minute default)

- a. Up arrow = Adds 1-minute increments
- b. Down arrow = Decreases 1-minute increments
- c. Range = 2-20 minutes



Temperature and Humidity Calibration Mode

Note: Use a calibrated temperature or humidity source when adjusting INSTEON Thermostat

- 1) Press and hold the Program button, tap Time/Sensor to enter Temperature Calibration Mode.
- 2) Tap Mode to step between temperature calibration and humidity calibration.

Temperature Calibration

- The top left number (77 in example) is the current reading according to the temperature sensor.
 - The top right number (14 in example) is the current offset (represents 1.4).
 - These numbers can change while this screen is displayed even though the primary temperature does not change. They are floating point calculations.
- 3) Tap Up or Down arrows to adjust the displayed temperature to match the calibrated source.
 - i. Each press results in a 1° F (0.5° C) change.
 - ii. The calculation using example numbers below is $78 = 77 + 1.4$.
 - iii. The offset range is from -10 to +10 actual degrees.

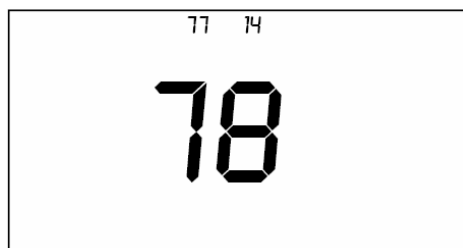

Humidity Calibration Mode

- 1) Once in Setup Mode for temperature calibration (step 1 above), tap Mode button to step between temperature calibration and humidity calibration.
- 2) Press the Up or Down arrow to select the current humidity level.
 - The top left number (40 in example) is the current reading according to the humidity sensor.
 - The top right number (-92 in example) is the current offset (represents -9.2).
 - These numbers can change while this screen is displayed even though the primary humidity level does not change. They are floating point calculations.
 - i. Each press results in a 1% humidity change.
 - ii. The calculation using example numbers below is $(31 = 40 - 9.2)$ and $42 = 40 + 1.7$.
 - iii. The offset is from -10 to +10.
- 3) Press Program to exit calibration mode.

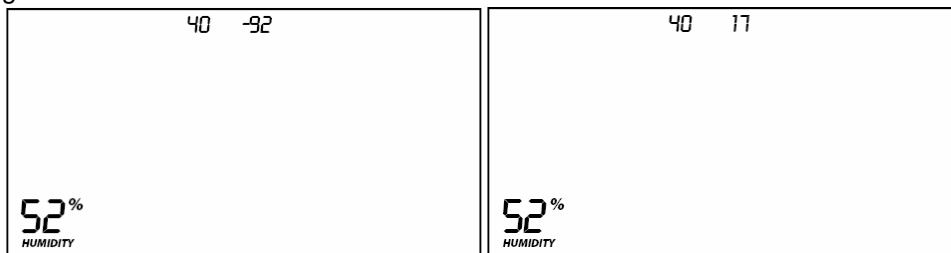

Advanced 2-Stage Heating or Cooling Systems

Two-stage air conditioners offer a more efficient, energy-saving way to cool your home. Two-stage cooling means that the air conditioner has a compressor with two levels of operation. A 2-stage unit produces more even heating and cooling temperatures.

INSTEON Thermostat's second stage of heat or cool engages under the following conditions:

- INSTEON Thermostat's setpoint is set at 5°(F or C) or more below ambient in Cool mode and 5°(F or C) or more above ambient in Heat mode.
 - Heat mode setpoint is 80°, ambient is 72° = first and second stage engaged
 - Cool mode setpoint is 78°, ambient is 84° = first and second stage engaged
- INSTEON Thermostat has been active in Heat or Cool for longer than 10 minutes and did not reach setpoint.
 - Heat mode ran for 10 minutes and did not reach setpoint = second stage engaged.
 - Cool mode ran for 10 minutes and did not reach setpoint = second stage engaged.

Note: It is possible for INSTEON Thermostat to occasionally engage and disengage second stage during a single heating or cooling cycle as variables are met.

Factory Reset

If you want to reset INSTEON Thermostat to its factory default settings, follow instructions below.

Note: If you choose to reset INSTEON Thermostat to its factory default settings, it is important that you remove scene memberships from all controllers. Otherwise, controllers will retry commands repetitively, creating network delays. Follow the instructions in *Removing INSTEON Thermostat as an INSTEON Responder* above for each scene controller of which INSTEON Thermostat is a member.

Factory reset changes:

- INSTEON is reset (all scene memberships are removed)
- Day/time is changed to 12:00AM Monday
- Programming times, temperatures and other settings are reset to their default values

Factory reset does not change:

- Temperature offset
- Humidity offset

Factory Reset

- 1) Press and hold INSTEON Thermostat's Set button until it beeps.
INSTEON Thermostat will beep.
INSTEON Thermostat Set LED will blink green.
- 2) Press and hold INSTEON Thermostat's Set button again until it beeps.
INSTEON Thermostat will beep.
INSTEON Thermostat Set LED will blink red.
- 3) Double-tap Set button.
- 4) Press and hold Set button again for about 10 seconds.
INSTEON Thermostat will emit a long beep and its display will blink all segments.
- 5) When blinking/buzzing stops, release Set button and wait 10 seconds.
INSTEON Thermostat will perform a series of self tests, then return to normal operations.
INSTEON Thermostat display will return to normal.

Specifications

| General | |
|----------------------------------|---|
| Product name | INSTEON Thermostat |
| Brand/manufacturer | INSTEON |
| Manufacturer product number | 2441TH US 2732-422 EU 2732-522 AUS/NZ |
| UPC | 813922-010824 US/Can 813922-012859 EU 813922-012866 AUS/NZ |
| Warranty | 2 years, limited |
| INSTEON | |
| INSTEON powerline mesh repeater | No |
| INSTEON RF mesh repeater | Yes |
| INSTEON controller | Yes |
| INSTEON responder | Yes |
| Maximum links/scenes | 400 |
| LED | Red when Heating is active, green when Cooling is active Off when neither mode is active Blinks red or green during setup |
| LED brightness | LED can be enabled or disabled locally or via software |
| Local control | Yes |
| Commands supported as controller | On Off |
| Commands supported as responder | On Off |
| | Beep |

| | | |
|-----------------------------|---|------|
| Software configurable | Yes | |
| RF range | Up to 150-Feet (50m) open air | |
| Phase bridge detect beacon | No, RF only device | |
| INSTEON device category | 0x05 (all frequencies) | |
| INSTEON device subcategory | 2441TH (915 MHz) | 0x0B |
| | 2732-422 (869 MHz) | 0x0F |
| | 2732-522 (921 MHz) | 0x10 |
| X10 | | |
| X10 address | N/A | |
| X10 transmitter | N/A | |
| X10 receiver | N/A | |
| X10 status response | N/A | |
| X10 resume dim | N/A | |
| X10 minimum transmit level | N/A | |
| X10 minimum receive level | N/A | |
| X10 messages repeated | N/A | |
| Mechanical | | |
| Mounting | Wall mount | |
| Wire connections | Common 24V | |
| | Power 24V | |
| | Heat 1 | |
| | Heat 2 | |
| | Fan | |
| | Cooling 1 | |
| | Cooling 2 | |
| Screw clamp connections | Yes, 10 position | |
| Case color | White | |
| Set button | 1 | |
| Plastic | UV stabilized ABS | |
| Beeper | Yes | |
| Beep on button press | Optional (off by default) | |
| LED | 1 dual-color red/green | |
| Dimensions | 5.7" x 3.6" x 1.1" (14.5cm x 9.1cm x 2.8cm) | |
| Weight | 0.46 lbs, 7.4oz., 208g | |
| Operating environment | Indoors | |
| Operating temperature range | 4° to 40° C (39° to 104° F) | |
| Operating humidity range | 0-90% relative humidity | |
| Storage temperature range | -20° to 70° C (-4° to 158° F) | |
| Electrical | | |
| Voltage | 24VAC | |

| | |
|------------------------------------|--|
| Frequency | 50/60 Hz Note: This is an RF device. Frequency shown because AC provided from HVAC system. |
| Load type(s) | HVAC |
| Maximum load | N/A |
| Minimum load | N/A |
| User replaceable fuse | No |
| Hardwired remote control | N/A |
| Retains all settings without power | Yes, saved in non-volatile EEPROM |
| Standby power consumption | < 0.75 watts |
| Certifications | FCC ID Pat 15B & 15C and IC: RSS-210 Issue 8 (US/Can) ETSI EN 300 220-1 & 220-2, ETSI EN 301 489-1 & 489-3 (Eu) AS/NZ 4268 (C-Tick N16509) |
| FCC I.D. | SBP2441T |
| Marks | WEEE, RoHS (All models) C-Tick N16509 (Aus/NZ model) |
| Safety approval(s) | N/A, low voltage device |

Troubleshooting

| Problem | Possible cause | Solution |
|--|--|---|
| After screwing into wall, INSTEON Thermostat's front face pops open and has a hard time staying closed. | The protective shielding on the cable jacket was not stripped back enough, interfering with components. | Strip back protective shielding so face snaps in securely. |
| The A/C is not working after installing INSTEON Thermostat. | You may have accidentally shorted the common wire, which shorted the transformer. | Replace the common wire. |
| After powering up or a factory reset, INSTEON Thermostat displays a two-digit error code instead of the ambient temperature. | It didn't boot up fully. | Open INSTEON Thermostat and tap the reset button. Close the unit and wait for it to reboot. If problem persists, call the INSTEON Support Line. |
| I replaced my INSTEON Thermostat with a new one, but now SmartLinc and INSTEON app don't recognize it. | SmartLinc and the INSTEON app communicate via INSTEON I.D.s. They are still trying to communicate to the old thermostat's I.D. | Update the INSTEON I.D. on both SmartLinc and the INSTEON app with your new thermostat's I.D. |

DECLARATION OF CONFORMITY

Hereby, INSTEON declares that this device is in compliance with the essential requirements and other relevant provisions of the following Directives:

- 1) **Electromagnetic Compatibility Directive 2004/108/EC**
- 2) **Hazardous Substance Directive 2005/95/EC**

Technical data and copies of the original Declaration of Conformity are available and can be obtained from INSTEON; 16542 Millikan Ave, Irvine, CA, USA.

User Information for Consumer Products Covered by EU Directive 2002/96/EC on Waste Electric and Electronic Equipment (WEEE)

This document contains important information for users with regards to the proper disposal and recycling of INSTEON products. Consumers are required to comply with this notice for all electronic products bearing the following symbol:

Environmental Information for Customers in the European Union

European Directive 2002/96/EC requires that the equipment bearing this symbol on the product and/or its packaging must not be disposed of with unsorted municipal waste. The symbol indicates that this product should be disposed of separately from regular household waste streams.

It is your responsibility to dispose of this and other electric and electronic equipment via designated collection facilities appointed by the government or local authorities. Correct disposal and recycling will help prevent potential negative consequences to the environment and human health. For more detailed information about the disposal of your old equipment, please contact your local authorities, waste disposal service, or the shop where you purchased the product.

DECLARATION OF CONFORMITY TO R&TTE DIRECTIVE 1999/5/EC for the European Community, Switzerland, Norway, Iceland and Liechtenstein

Product category: general consumer (category 3).

English: This equipment is in compliance with the essential requirements and other relevant provisions of the European R&TTE Directive 1999/5/EC

Deutsch [German]: Dieses Gerät entspricht den grundlegenden Anforderungen und den weiteren entsprechenden Vorgaben der Richtlinie 1999/5/EU.

Nederlands [Dutch]: Dit apparaat voldoet aan de essentiële eisen en andere van toepassing zijnde bepalingen van de Richtlijn 1999/5/EC.

Svenska [Swedish]: Denna utrustning står i överensstämmelse med de väsentliga egenskapskrav och övriga relevanta bestämmelser som framgår av direktiv 1999/5/EG.

Français [French]: Cet appareil est conforme aux exigences essentielles et aux autres dispositions pertinentes de la Directive 1999/5/EC

Español [Spanish]: Este equipo cumple con los requisitos esenciales así como con otras disposiciones de la Directiva 1999/5/CE.

Português [Portuguese]: Este equipamento está em conformidade com os requisitos essenciais e outras provisões relevantes da Directiva 1999/5/EC.

Italiano [Italian]: Questo apparato é conforme ai requisiti essenziali ed agli altri principi sanciti dalla Direttiva 1999/5/CE.

Norsk [Norwegian]: Dette utstyret er i samsvar med de grunnleggende krav og andre relevante bestemmelser i EU-direktiv 1999/5/EF.

Suomi [Finnish]: Tämä laite täyttää direktiivin 1999/5/EY olennaiset vaatimukset ja on siinä asetettujen muiden laitetta koskevien määräysten mukainen.

Dansk [Danish]: Dette udstyr er i overensstemmelse med de væsentlige krav og andre relevante bestemmelser i Direktiv 1999/5/EF.

Polski [Polish]: Urządzenie jest zgodne z ogólnymi wymaganiami oraz szczególnymi warunkami określonymi Dyrektywą UE: 1999/5/EC



Certification and Warranty

FCC and Industry Canada Compliance Statement

This device complies with FCC Rules Part 15 and Industry Canada RSS-210. Operation is subject to the following two conditions:

- (1) This device may not cause harmful interference, and
- (2) This device must accept any interference, including interference that may cause undesired operation of the device.

Le present appareil est conforme aux CNR d'Industrie Canada applicables aux appareils radio exempts de licence. L'exploitation est autorise aux deux conditions suivantes:

- (1) l'appareil ne doit pas produire de brouillage, et
- (2) l'utilisateur de l'appareil doit accepter tout brouillage radioelectrique subi, mme si le brouillage est susceptible d'en compromettre le fonctionnement.

The digital circuitry of this device has been tested and found to comply with the limits for a Class B digital device, pursuant to Part 15 of the FCC Rules. These limits are designed to provide reasonable protection against harmful interference in residential installations. This equipment generates, uses, and can radiate radio frequency energy and, if not installed and used in accordance with the instructions, may cause harmful interference to radio and television reception. However, there is no guarantee that interference will not occur in a particular installation. If this device does cause such interference, which can be verified by turning the device off and on, the user is encouraged to eliminate the interference by one or more of the following measures:

- Re-orient or relocate the receiving antenna of the device experiencing the interference
- Increase the distance between this device and the receiver
- Connect the device to an AC outlet on a circuit different from the one that supplies power to the receiver
- Consult the dealer or an experienced radio/TV technician

WARNING: Changes or modifications to this device not expressly approved by the party responsible for compliance could void the user's authority to operate the equipment.

Limited Warranty

Seller warrants to the original consumer purchaser of this product that, for a period of two years from the date of purchase, this product will be free from defects in material and workmanship and will perform in substantial conformity to the description of the product in this Owner's Manual. This warranty shall not apply to defects or errors caused by misuse or neglect. If the product is found to be defective in material or workmanship, or if the product does not perform as warranted above during the warranty period, Seller will either repair it, replace it, or refund the purchase price, at its option, upon receipt of the product at the address below, postage prepaid, with proof of the date of purchase and an explanation of the defect or error. The repair, replacement, or refund that is provided for above shall be the full extent of Seller's liability with respect to this product. For repair or replacement during the warranty period, call the INSTEON Support Line at 800-762-7845 with the Model # and Revision # of the device to receive an RMA# and send the product, along with all other required materials to:

INSTEON
ATTN: Receiving
16542 Millikan Ave.
Irvine, CA 92606-5027

Limitations

The above warranty is in lieu of and Seller disclaims all other warranties, whether oral or written, express or implied, including any warranty or merchantability or fitness for a particular purpose. Any implied warranty, including any warranty of merchantability or fitness for a particular purpose, which may not be disclaimed or supplanted as provided above shall be limited to the two-year of the express warranty above. No other representation or claim of any nature by any person shall be binding upon Seller or modify the terms of the above warranty and disclaimer.

Home automation devices have the risk of failure to operate, incorrect operation, or electrical or mechanical tampering. For optimal use, manually verify the device state. Any home automation device should be viewed as a convenience, but not as a sole method for controlling your home.

In no event shall Seller be liable for special, incidental, consequential, or other damages resulting from possession or use of this device, including without limitation damage to property and, to the extent permitted by law, personal injury, even if Seller knew or should have known of the possibility of such damages. Some states do not allow limitations on how long an implied warranty lasts and/or the exclusion or limitation of damages, in which case the above limitations and/or exclusions may not apply to you. You may also have other legal rights that may vary from state to state.

U.S Patent No. 7,345,998, International patents pending
© Copyright 2012 INSTEON, 16542 Millikan Ave., Irvine, CA 92606, 800-762-7845, www.insteon.com