

INSTEON[®] Wireless Thermostat

Owner's Manual

2732-232, 2441ZTH (US)

2732-432 (EU)

2732-532 (AUS/NZ)



I
N
S
T
E
O
N[®]

What's in the Box?	3
INSTEON Wireless Thermostat Button Overview	4
INSTEON Wireless Thermostat Operation and Programming	5
<i>Mode Button Operation</i>	5
<i>Energy Button Operation</i>	6
<i>Set Button Operation</i>	7
<i>Time/Sensor Button Operations</i>	7
<i>Program Button Operation</i>	8
<i>Fan and Hold Button Operations</i>	9
<i>Master Button Operation</i>	10
Optional Accessories	11
<i>Waterproof Temperature Sensor (2433A3)</i>	11
<i>Power Supply</i>	11
Installation	11
<i>Preparation</i>	11
<i>Test Operation</i>	12
Adding INSTEON Wireless Thermostat to an INSTEON Thermostat	12
INSTEON Programming	13
<i>Add INSTEON Wireless Thermostat as a Controller</i>	13
<i>Remove INSTEON Wireless Thermostat as a Controller</i>	14
<i>User Setup Mode Overview</i>	15
<i>User Setup Mode</i>	16
<i>Temperature and Humidity Calibration Modes</i>	18
Advanced 2-Stage Heating or Cooling Systems	20
Factory Reset	20
Specifications	21
Troubleshooting	23
Certification and Warranty	26
FCC and Industry Canada Compliance Statement	26
Limited Warranty	27
Limitations	27

What's in the Box?

- INSTEON Wireless Thermostat
- Quick Start Guide
- Tabletop stand (removable for wall-mounting)



INSTEON Wireless Thermostat Button Overview

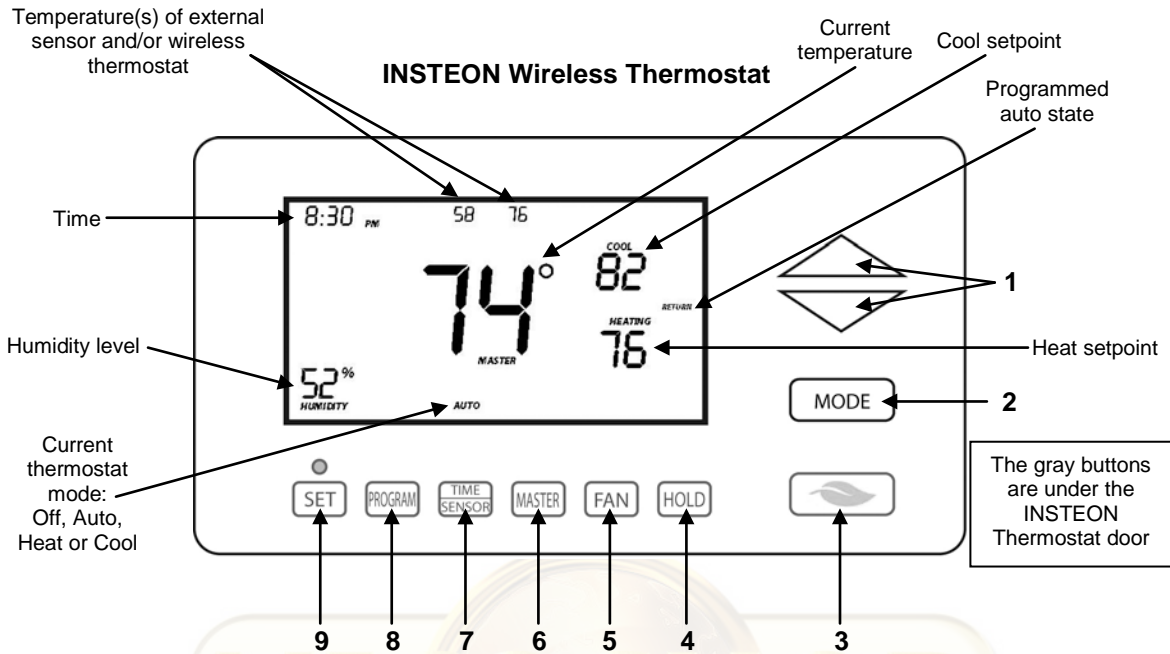

- 1) **Up/Down** adjusts the temperature setpoint based on the current mode
- 2) **Mode** allows the user to select the current operational mode of the HVAC system. It cycles between Off, Heat, Cool, Auto and Programmed Auto.
- 3) **Energy** button is a quick option that saves energy (and money). When pressed, it sets back the setpoint by a specified value. The default value is 4° from the current setting. To change the default offset value to be a value other than 4°, you must use software, such as HouseLinc.
- 4) **Hold** overrides a pre-programmed mode
- 5) **Fan** cycles between Auto and Always On
- 6) **Master** makes this device the master temperature controller. Pressing and holding "Master" does not alter any scene or screen settings. It just defines this INSTEON Wireless Thermostat as the master temperature controller.
- 7) **Time/Sensor** button allows you to set the date and time. It cycles between hour, minute and time format.
- 8) **Program** button allows you to setup the various pre-programmed user modes
- 9) **Set** button adds and removes INSTEON Wireless Thermostat from scenes. It functions like the Set button on other INSTEON devices.

INSTEON Wireless Thermostat Operation and Programming

Mode Button Operation

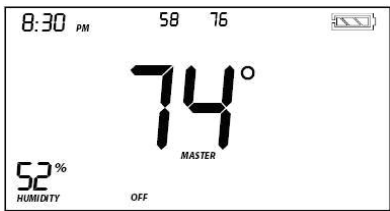

Off Mode:

- No setpoints are shown
- Up/Down arrows do not do anything

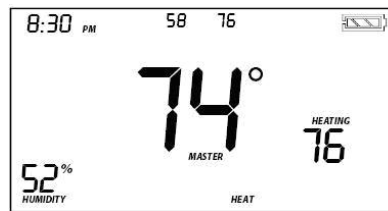

Heat Mode:

- Only Heat setpoint is shown
- Up/Down arrows change Heat setpoint
- Heat setpoint range: 35°-95°F (2°C-36°C)

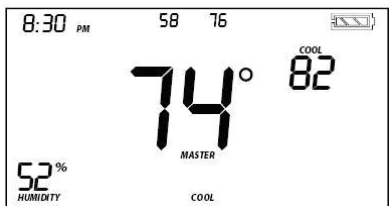

Cool Mode:

- Only Cool setpoint is shown
- Up/Down arrows change Cool setpoint
- Cool setpoint range: 37°-97°F (4°C-38°C)

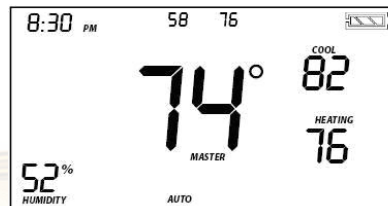

Auto Mode:

- Both Cool and Heat setpoints are shown
- Up/Down arrows increase or decrease values by the same amount

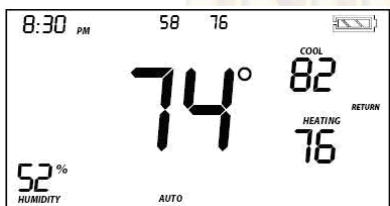

Programmed Auto Mode:

- The active program mode is indicated by one of four annotations: Wake, Leave, Return or Sleep
- The annotation (Wake, Leave, Return or Sleep) is not displayed in the other four modes (Off, Heat, Cool or Auto)
- Both Cool and Heat setpoints are shown
- Up/Down arrows increase or decrease values by the same amount
- When the thermostat moves to the next time period, the setpoints will be adjusted accordingly

Note:

- To adjust the gap between setpoints in Auto mode, press Mode to select Heat and set the temperature you desire. Press Mode again to select Cool and set the temperature you desire. Press Mode a third time to return to Auto; the settings will reflect your changes.

- If you set Heat and Cool to the same temperature setpoint, Heat will automatically move down 2° (the minimum allowable gap).

Energy Button Operation

The Energy button (designated with the leaf) is a quick, efficient energy-saving option. When you press the Energy button, INSTEON Wireless Thermostat will adjust the Heat and Cool setpoints by a specified value. The default value is 4° from the current setting, but can be changed via home control software such as HouseLinc.

- When you exit Energy mode, it will revert back the 4° that was changed upon entry.
- The unit remains in Energy mode until the Energy button is pressed again.
- Up/Down arrows adjust the temperature setpoint based on the mode you are in.

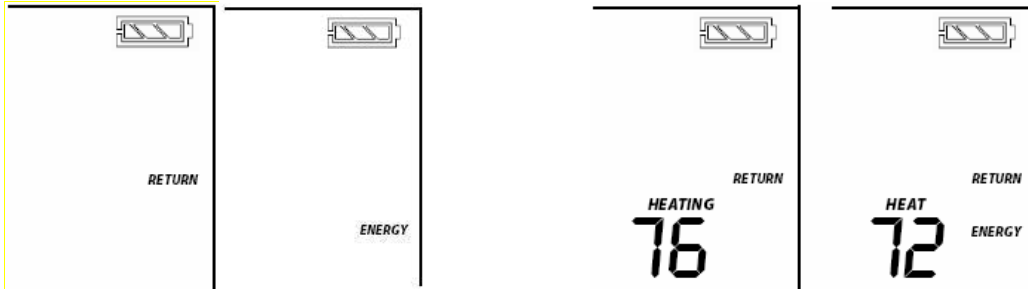

From Off Mode:

- Energy button does nothing because the system is off (at maximum energy savings already)
- When “Energy” appears on the screen for Auto, Cool and Heat Modes, the 4° setback is engaged

From Heat Mode:

- Heat setback as specified
- Default setback is 4° less
- Notice that “Heating” is active on the left, but not on the right since the setpoint is lower than the actual temperature; the element reads “Heat”

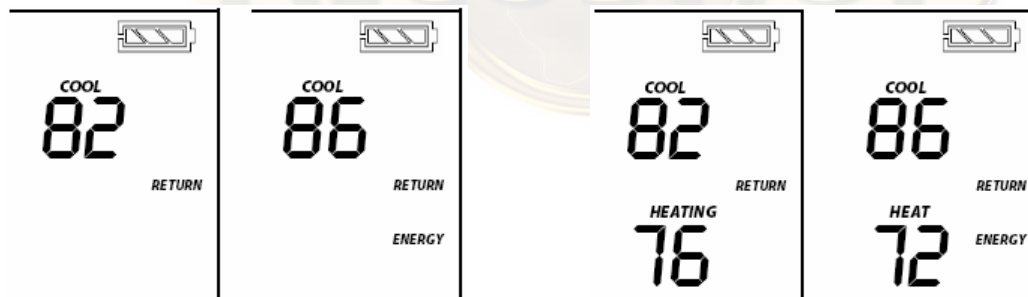

From Cool Mode:

- Cool setback as specified
- Default setback is 4° more

From Auto Mode:

- Both Heat and Cool setpoints changed as specified
- Default setback is 4° more for Cooling and 4° less for Heating
- Notice that “Heating” is active on the left, but not on the right since the setpoint is lower than the actual temperature; the element reads “Heat”

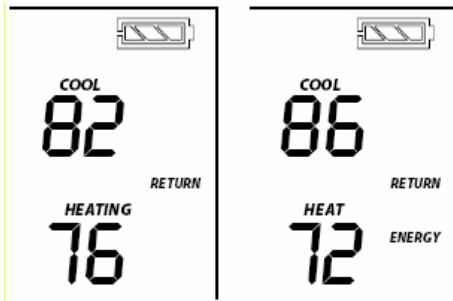

From Programmed Auto Mode:

- Both Heat and Cool setpoints changed as specified
- Default setback is 4°
- Notice that "Heating" is active on the left, but not on the right since the setpoint is lower than the current temperature; the element reads "Heat"

Note: Onscreen text displaying "Heat" changes to "Heating" and "Cool" changes to "Cooling" to indicate HVAC system is active.

Set Button Operation

The Set button adds and removes INSTEON Wireless Thermostat from INSTEON scenes. It functions like the Set button on other INSTEON devices.

Time/Sensor Button Operations

- The Time/Sensor button allows the user to set the time and clock format.
- Button cycles among hour, minute and 12-/24-hour format. *Note: When added to a scene with INSTEON Thermostat, INSTEON Wireless Thermostat automatically retrieves time settings from INSTEON Thermostat.*
- Up/Down arrows cycle through the available options.
- Go to the next Time/Sensor step by pressing Time/Sensor button again.
- Exit Time/Sensor setup by:
 - Letting it time out after 4 minutes.
 - Pressing Mode button

IMPORTANT! Once you have added INSTEON Wireless Thermostat to a scene in INSTEON Thermostat as a wireless temperature zone, the Time/Sensor button will allow you to change time format (12- or 24-hour) but time information will be provided by INSTEON Thermostat.

Note: Colors indicate element that is presently blinking during setting procedure.

First press of Time/Sensor: Hours settings

- Up/Down arrows cycle through time in 1-hour increments
- Pressing and holding Up/Down arrows cycles through faster

Note: AM/PM changes automatically as needed.

Second press of Time/Sensor: Minutes settings

- Up/Down arrows cycle through time in 1-minute increments
- Pressing and holding Up/Down arrows cycles through faster



Third press of Time/Sensor:

Clock Format setting (12- or 24-Hour clock)

- Entire time line blinks
- Up/Down arrows cycle between 12- and 24-hour clock format

Note: AM/PM is not displayed when in 24-hour format.

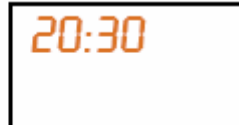

Program Button Operation

- The Program button allows you to set up the various preprogrammed modes (Wake, Leave, Return and Sleep).
- Go to the next step by pressing Program again.
- Exit Program setup by:
 - Letting it time out after 4 minutes.
 - Pressing Mode button

IMPORTANT! Once you have added INSTEON Wireless Thermostat to a scene in INSTEON Thermostat as a wireless temperature zone, the Program button will no longer function. All program controls will be performed on the INSTEON Thermostat.

Note: Text colors below indicate element that is presently blinking during setting procedure.

First press of Program:

Selects from available pre-program modes

Up/Down arrows cycle through Wake, Leave, Return and Sleep.

NOTE:

- Energy is not a part of this option
- Once a preprogrammed mode is selected, that item remains displayed throughout to indicate the mode you are programming
- The current mode settings are displayed on the thermostat at each setup step



Second press of Program:

Start Time

- Up/Down arrows cycle through time in 15-minute increments. *Note: when pressing the Down arrow, if you come within 15 minutes of another preprogrammed mode time, you will not be able to increase the time any further.*
- Pressing and holding Up/Down arrows cycles through faster

Note: AM/PM changes automatically as needed.



Note: The start of one program mode is also the end of the previous program mode.

Third press of Program:

Cool setpoint

- Up/Down arrows cycle through temperature
- Press and hold scrolls through temperatures



Fourth press of Program:

Heat setpoint

- Up/Down arrows cycle through temperature
- Press and hold scrolls through temperatures



Fifth press of Program:

Restarts the process to program another Mode/Day.

NOTE: The four modes come preprogrammed. The defaults are for all days:

Day Modes	Start Time	Thermostat Mode	Heat Setting	Cool Setting
Wake	6:00AM	Auto	65°F 18°C	75°F 24°C
Leave	8:30AM	Auto	60°F 16°C	80°F 27°C
Return	5:00PM	Auto	65°F 18°C	75°F 24°C
Sleep	11:00PM	Auto	60°F 16°C	80°F 27°C

Note: To exit program setup mode, press Mode button once.

Fan and Hold Button Operations

Fan button operations

- The Fan button is only functional when INSTEON Wireless Thermostat is linked to an INSTEON Thermostat
- The Fan button cycles between Auto and Always On
- On the display, it simply indicates the text “Fan Always” when selected. There is no text for Auto.



Always On



Auto

Hold button operations

- The Hold button is only functional in Auto Program mode
- The Hold button overrides a preprogrammed mode until Hold is turned off

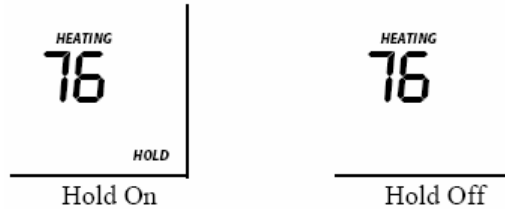

IMPORTANT:

- While Hold is enabled, the next preprogrammed time that comes in Preprogrammed Auto Mode will be ignored.
- While Hold is enabled, the preprogrammed time notations are not shown (i.e. Wake, Leave, Return and Sleep).
- Hold can be remotely enabled/disabled from an INSTEON controller.

Master Button Operation

First press and hold:

Makes the local INSTEON Wireless Thermostat the master temperature controller

- To perform this, press and hold Master button for 3 seconds.
INSTEON Wireless Thermostat will beep once.
- Release.

Note: This is only valid if INSTEON Wireless Thermostat is linked to a INSTEON Thermostat.

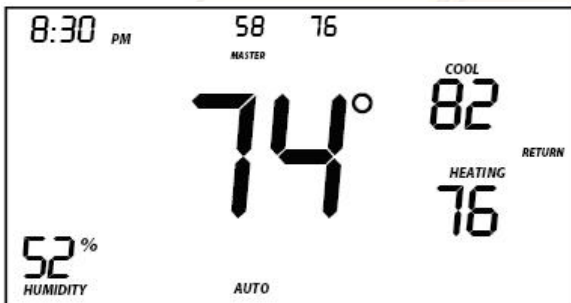

Before pressing Master button:

- Notice that the left remote sensor is currently the Master temperature controller

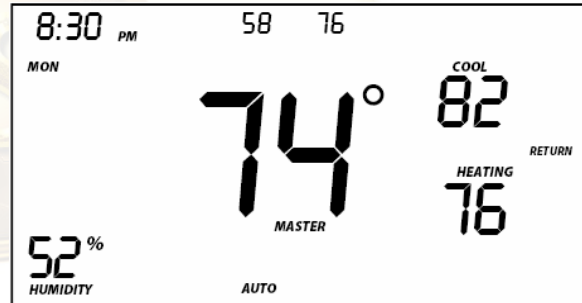

After pressing and holding Master button:

- Notice that the left remote sensor is no longer the Master temperature controller
- The local INSTEON Wireless Thermostat is now the Master controlling temperature

Note: If no INSTEON scene is programmed to an INSTEON Wireless Thermostat, pressing and holding for 3 seconds will have no function.

Optional Accessories

Waterproof Temperature Sensor (2433A3)

INSTEON Waterproof Temperature Sensor is an external sensor that wires to your INSTEON Wireless Thermostat. When connected, the thermostat's LCD display will show the sensor readings in small digits above the thermostat's temperature.

Waterproof Temperature Sensor can be extended up to 100' with 22 AWG wire. It's ideal for monitoring and maintaining constant temperatures in environments like pools, spas, aquariums and ponds.



Power Supply

INSTEON Wireless Thermostat includes a connection for an AC power supply. Any generic AC/DC adapter that has a 5-7.5V and 200mA output will work. (Do not use an adapter greater than 7.5V to avoid damaging the thermostat.) When connected to external power, INSTEON Wireless Thermostat will automatically switch from battery power to external power (batteries can remain installed) and will stay on and awake all the time. If external power is lost, INSTEON Wireless Thermostat will switch back to battery power. Install power supply as follows:

- 1) Open the back of INSTEON Wireless Thermostat
- 2) Locate the wiring block for the power supply. It should be the two left screws.
- 3) Use a flathead screwdriver to loosen screws
- 4) Route power supply cable through hole in back of thermostat case
- 5) Connect power supply's exposed copper wire strands to terminal block, making sure the wires are in the correct positive/negative polarities
- 6) Tighten screws
- 7) Close back case

INSTEON Wireless Thermostat will automatically turn on and switch to external power

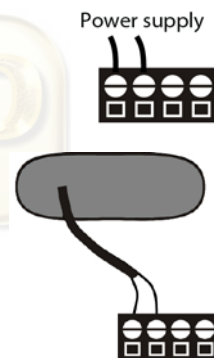

Installation

CAUTIONS AND WARNINGS

Read and understand these instructions before installing and retain them for future reference.

Preparation

Follow these steps to properly install INSTEON Wireless Thermostat. This thermostat will mainly be used on a tabletop; wall mounting is optional.

- 1) Make sure the location that you have selected for INSTEON Wireless Thermostat will not be affected by daily sun movement or be in direct line of sight of a nearby HVAC vent or fan
- 2) Insert 2 AA batteries into INSTEON Wireless Thermostat (high quality alkaline batteries recommended)
- 3) Close the INSTEON Wireless Thermostat cover

- After a few seconds INSTEON Wireless Thermostat will display ambient temperature and humidity
 - Mode will default to OFF
 - Battery segment should show full with fresh batteries
 - Time will become active and show 12:00PM (default)
- 4) Snap INSTEON Wireless Thermostat into the supplied tabletop stand or mount safely to a wall

Test Operation

INSTEON Wireless Thermostat does not directly control the HVAC system. Instead, INSTEON Wireless Thermostat communicates via RF to INSTEON Thermostat which is directly in contact to the wiring controlling the HVAC system.

Before adding INSTEON Wireless Thermostat as a responder or controller of INSTEON Thermostat, perform the following tests; these will help familiarize you with INSTEON Wireless Thermostat. Keep in mind you are not yet sending any communication to any INSTEON device. The INSTEON Wireless Thermostat is presently a standalone device.

Note: While testing, the display will change but no HVAC operations will take place.

INSTEON Wireless Thermostat defaults 5 minutes delay between cycling the AC compressor.

Heating Mode Test

- 1) Press Mode button once to enter Heat mode
- 2) Tap the up or down arrow several times until setpoint is 1° above ambient
*INSTEON Wireless Thermostat will call for Heat
"Heat" will change to "Heating," blink for 3 seconds and then turn on steady
No furnace activity will take place at this time, only display changes*
- 3) Tap the Up or Down arrow until you reach a desirable heat temperature setpoint below ambient

Cooling Mode Test

- 1) Tap Mode button once again to enter Cool mode
- 2) Tap the Up or Down arrow several times until setpoint is 1° below ambient
*INSTEON Wireless Thermostat will call for Cooling
"Cool" will change to "Cooling," blink for 3 seconds and then turn on steady
No A/C activity will take place at this time, only display changes*
- 3) Tap the Up or Down arrow until you reach a desirable cool temperature setpoint

Auto Mode Test

- 1) Tap Mode button once to enter Auto mode
Note that your Heat and Cool setpoints were set in previous steps, unless you did not have a minimum 2° gap between settings
- 2) Tap Up once to increase both Heat and Cool setpoints by 1°
- 3) Tap Down once to decrease both Heat and Cool setpoints by 1°
- 4) Tap Mode once to enter Programmed Auto mode
Indicated by Auto at bottom and relevant time of day to right of Heat/Cool set temps
- 5) Tap Mode twice to return to Off mode

Adding INSTEON Wireless Thermostat to an INSTEON Thermostat

Link INSTEON Wireless Thermostat to INSTEON Thermostat to provide a portable thermostat wherever you want temperature control. You can add up to two INSTEON Wireless Thermostats to an INSTEON Thermostat.

- 1) Press and hold INSTEON Wireless Thermostat Set button
INSTEON Wireless Thermostat will beep and its Set LED will blink green
- 2) Press and hold INSTEON Thermostat Set button

*INSTEON Thermostat will beep, then double-beep
INSTEON Wireless Thermostat will double-beep*

- 3) Test the scene by pressing and holding INSTEON Wireless Thermostat's Master button.
 - *When properly synchronized, pressing the Master button on one INSTEON Wireless Thermostat will illuminate the "Master" segment on that same screen. Additionally, the present room temperature of the Wireless Thermostat will be displayed in position 1 as temperature segments at the display's top center.*
 - *A visual inspection of each display will reveal Master status of INSTEON Thermostat or INSTEON Wireless Thermostat*

Note: Only INSTEON Thermostat is directly wired to the HVAC system. If you plan on operating multiple INSTEON Wireless Thermostats, you must have an INSTEON Thermostat installed to control the HVAC.

INSTEON Programming

Add INSTEON Wireless Thermostat as a Controller

INSTEON Wireless Thermostat can be set up to control other INSTEON devices or trigger software events when there is a change. The following INSTEON Wireless Thermostat changes can be configured as a controller (*note that when linked to an INSTEON Thermostat, these commands will not function*):

- Group 1 - Cooling mode change (scene control)
- Group 2 - Heating mode change (scene control)
- Group 3 - Dehumidification, high humidity setpoint (scene control)
- Group 4 - Humidification, low humidity setpoint (scene control)
- Group EF - Broadcast on any change (notification group for linked software controllers)¹

NOTE: An INSTEON Wireless Thermostat can also be added to a scene as a controller to Groups 1 - 4. When it is added as a controller of an INSTEON Thermostat, the setpoints between INSTEON Wireless Thermostat and INSTEON Thermostat will always be matched. When it is not added as a controller to a INSTEON Thermostat, the setpoints are local only.

Note: Humidity levels are taken from the local device only; they are not shared or matched among thermostats.

- 1) Press and hold INSTEON Wireless Thermostat Set button until it beeps.
INSTEON Wireless Thermostat Set LED will blink green
- 2) Tap Up or Down arrows to select from Groups 1-4 to add to a scene.
 - Group 1 – Cooling mode change (default)
 - Group 2 – Heating mode change
 - Group 3 – Dehumidification, high humidity setpoint
 - Group 4 – Humidification, low humidity setpoint
- 3) Adjust scene responder (such as OutletLinc with connected humidifier) to the state you want when scene is activated (e.g., 50%, 25% or even off)²
- 4) Press and hold responder Set button until it double-beeps or its LED flashes
*INSTEON Wireless Thermostat will double-beep upon completion
LED will turn off*
- 5) Confirm scene addition was successful by raising or lowering INSTEON Wireless Thermostat setpoint
After INSTEON Wireless Thermostat changes to active mode set in step 2 above, responder will toggle between the scene on-level and off
- 6) To add more responders to the scene, repeat steps 1-5 for each additional responder

¹ Group EF is a hexadecimal representation of Group 254 and can only be configured using software

² If the responder is a multi-scene device such as a KeypadLinc, tap the scene button you wish to control until its LED is in the desired scene state (on or off)

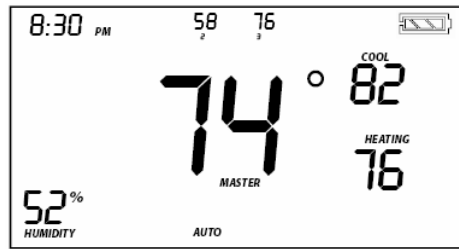

Upon entering Scene mode this screen will display for ~2 seconds



LCD display if Up button is tapped

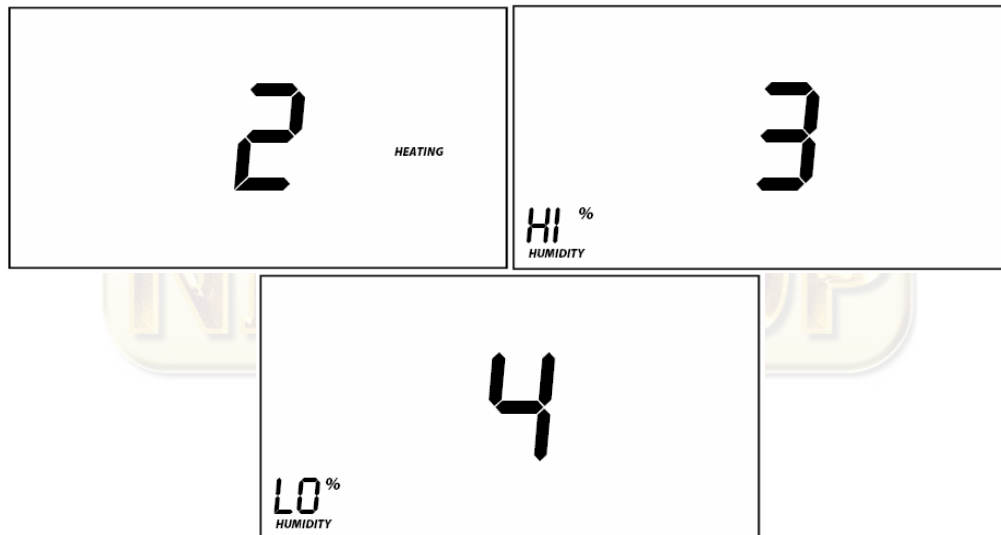

LCD displays when using Up or Down buttons to select from among the 4 controller groups

Remove INSTEON Wireless Thermostat as a Controller

If you want to remove INSTEON Wireless Thermostat from a scene as a controller, follow instructions below. Whenever possible, use software for managing scene memberships.

Note: If you choose to remove INSTEON Wireless Thermostat from use, it is important that you remove scene memberships from all responders. Follow the instructions below for each responder of which INSTEON Wireless Thermostat is a member.

- 1) Press and hold INSTEON Wireless Thermostat Set button until it beeps
INSTEON Wireless Thermostat Set LED will blink green
- 2) Press and hold INSTEON Wireless Thermostat Set button again to put it in scene mode
INSTEON Wireless Thermostat Set LED will blink red
LCD display indicates the group from which you are removing the scene
- 3) Tap Up and Down arrows to select appropriate group to remove from:
 - Group 1 - Cooling mode change, default

- Group 2 - Heating mode change
 - Group 3 - Dehumidification, high humidity setpoint
 - Group 4 - Humidification, low humidity setpoint
- 4) Press and hold responder Set button
INSTEON Wireless Thermostat will double-beep upon completion
LED will turn off

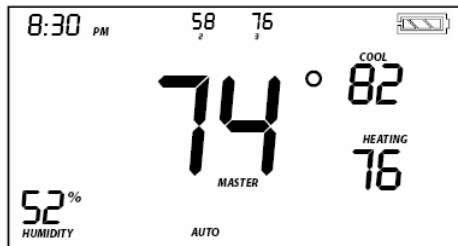

Upon entering Add a Scene mode



Upon entering Remove a Scene mode (defaults to Cooling mode)

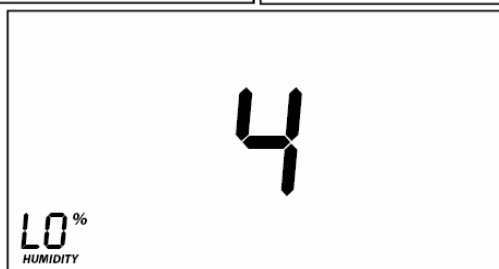
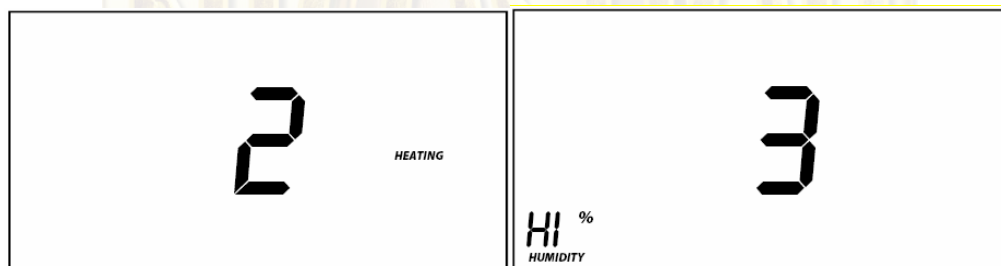

LCD displays when using Up or Down buttons to select from among the 4 controller groups

User Setup Mode Overview

IMPORTANT! Once you have added INSTEON Wireless Thermostat to INSTEON Thermostat, the Program and Time/Sensor buttons will no longer perform their initial functions. All program and time controls will be performed on the INSTEON Thermostat. To access the Program and Time/Sensor buttons again, you must remove INSTEON Wireless Thermostat from INSTEON Thermostat.

Program and Time/Sensor buttons can be used to wake INSTEON Wireless Thermostat up from its

battery-saving mode to retrieve any updates from INSTEON Thermostat.

Press and hold Program button for 3 seconds or more to enter User Setup Mode:

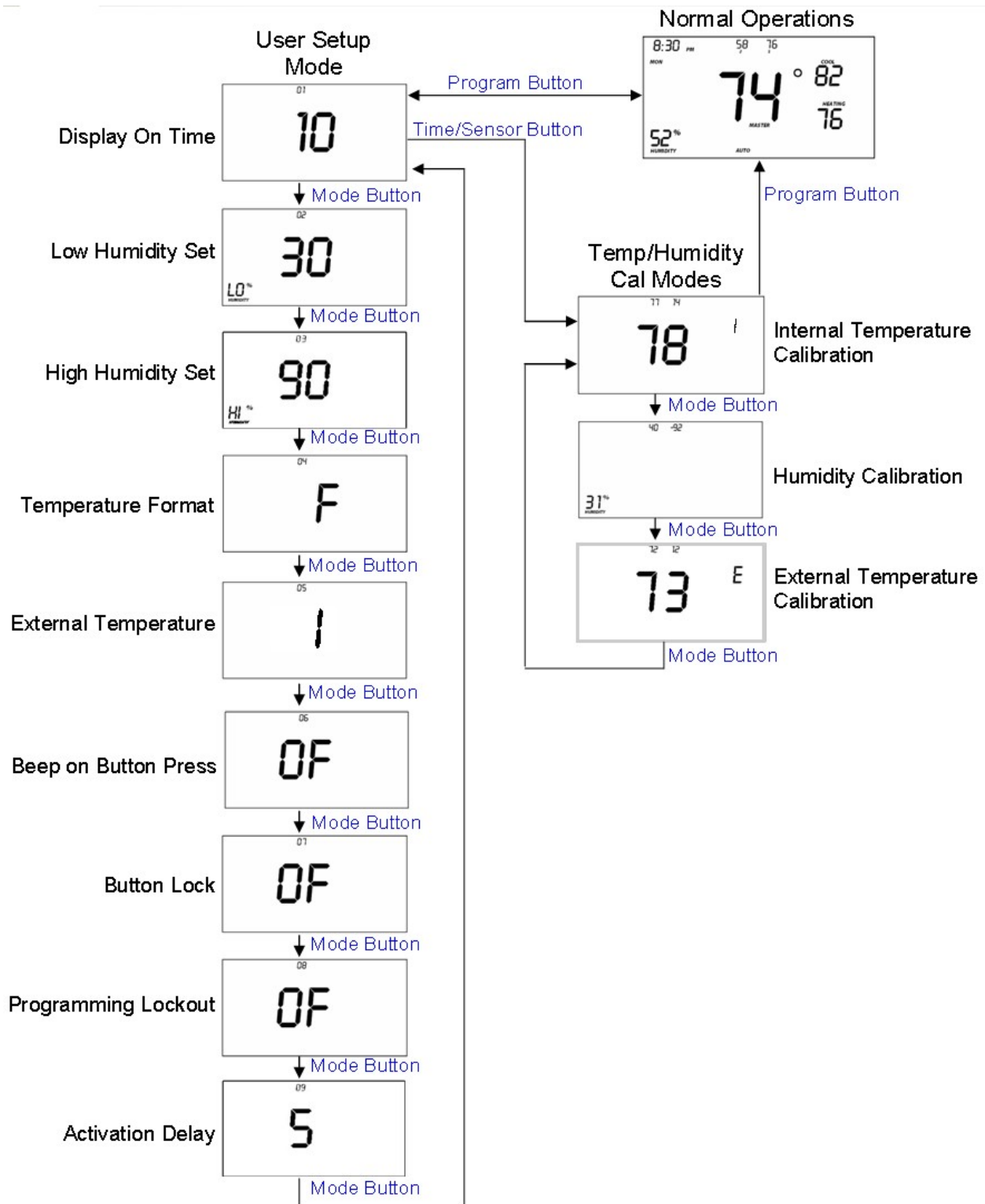

User Setup Mode

- 1) Press and hold Program button to access the following options:

- Press Mode to step between menu items (sub-mode number will appear on top of the screen).
 - Sub-mode 01: Display LED on-time select (default is 10 seconds)
 - Sub-mode 02: Humidity low setpoint (default is 30%)
 - Sub-mode 03: Humidity high setpoint (default is 90%)
 - Sub-mode 04: Temperature format select (default is Fahrenheit)
 - Sub-mode 05: Internal or External temperature sensor (default is Internal)
 - Sub-mode 06: Beep on button press (default is off)
 - Sub-mode 07: Button lock (default is off)
 - Sub-mode 08: Programming lock (default is off)
 - Sub-mode 09: Activation delay (default is 5 minutes)

2) Press the Up or Down arrow to change a setting

- Sub-mode 01: LED backlight ON time (10-second default)
 - a. Tap up or Down arrow to step between OFF, 10 seconds, 60 seconds and ON

Note: Do not set to ON unless you are connected to a power supply or the batteries will drain very rapidly.



- Sub-mode 02: Humidity low setpoint (humidification, 30% default)
 - a. Up arrow = Increase humidity % setpoint
 - b. Down arrow = Decrease humidity % setpoint
 - c. Press and hold arrow buttons to scroll
 - d. Range = 0 to 79% (humidity high setpoint will automatically adjust to be +20% than humidity low setpoint)



- Sub-mode 03: Humidity high setpoint (dehumidification, 90% default)
 - a. Up arrow = Increase humidity % setpoint
 - b. Down arrow = Decrease humidity % setpoint
 - c. Press and hold arrow buttons to scroll
 - d. Range = 20 to 99% (cannot come within 20% of humidity low setpoint)



- Sub- mode 04: Temperature format select (C or F, F default)
 - a. Up arrow = C
 - b. Down arrow = F



- Sub-mode 05: Chose whether the Internal or External temperature sensor initiates commands (Internal default)
 - a. Up arrow = External
 - b. Down arrow = Internal
 - c. Note that when using two INSTEON Wireless Thermostats with External temperature sensor enabled, each INSTEON Wireless Thermostat will only display its local reading and the INSTEON Thermostat's reading. (INSTEON Thermostat will display both INSTEON Wireless Thermostats' readings.)



- Sub-mode 06: Beep on button press (enable/disable, OFF default)
 - a. Up arrow = ON
 - b. Down arrow = OFF



- Sub-mode 07: Button lock (enable/disable, OFF default)
 - a. Up arrow = ON
 - b. Down arrow = OFF



- Sub-mode 08: Programming lock (enable/disable, OFF default)
 - a. Up arrow = ON
 - b. Down arrow = OFF



- Sub-mode 09: Activation delay (default is 5 minutes)
 - a. Up arrow = Increase activation delay time
 - b. Down arrow = Decrease activation delay time
 - c. Range = 2 to 20 minutes



3) When finished, press and hold Program button to exit

Temperature and Humidity Calibration Modes

Note: Use a calibrated temperature or humidity source when adjusting INSTEON Wireless Thermostat.

- 1) Press and hold the Program button
- 2) Tap Time/Sensor to enter Temperature Calibration Mode
- 3) Tap Mode to step among internal temperature calibration (I), humidity calibration and external

temperature calibration modes (E)

Internal Temperature Calibration

- I appears on right side of screen
 - The top left number (77 in example) is the current reading according to the temperature sensor
 - The top right number (14 in example) is the current offset (represents 1.4)
 - These numbers can change while this screen is displayed even though the primary temperature does not change; they are floating point calculations.
- 1) Tap Up or Down arrows to adjust the displayed temperature to match the calibrated source
 - i. Each press results in a 1° F (0.5° C) change
 - ii. The calculation using example numbers below is $78 = 77 + 1.4$
 - iii. The offset range is from -10 to +10 actual °s



Humidity Calibration Mode

- 1) Once in Setup Mode for temperature calibration (step 1 above), tap Mode button to step between temperature calibration and humidity calibration
- 2) Press the Up or Down arrow to select the current humidity level
 - The top left number (40 in example) is the current reading according to the humidity sensor
 - The top right number (-92 in example) is the current offset (represents -9.2)
 - These numbers can change while this screen is displayed even though the primary humidity level does not change. they are floating point calculations
 - Each press results in a 1% humidity change
 - The calculation using example numbers below is $(31 = 40 - 9.2)$ and $42 = 40 + 1.7$
 - The offset is from -10 to +10
- 3) Press the MODE button to calibrate the external temperature sensor or press Program to exit calibration mode

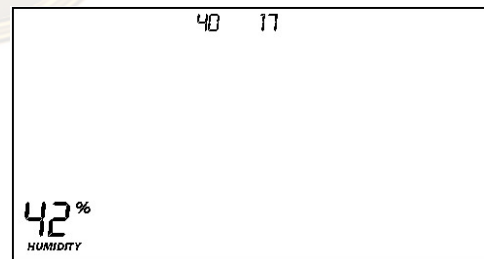
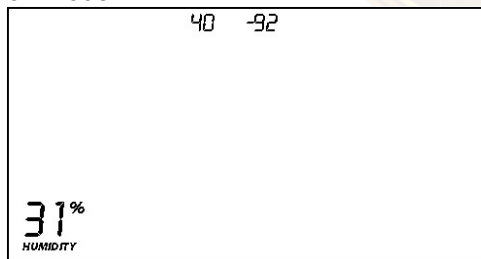

External Temperature Calibration

- If you are using a Waterproof Temperature Sensor, use this mode to calibrate its external temperature readings
 - E appears on right side of screen
- 1) Tap Up or Down arrows to adjust the displayed temperature to match the calibrated source
 - i. Each press results in a 1° F (0.5° C) change
 - ii. The calculation using example numbers below is $78 = 77 + 1.4$
 - iii. The offset range is from -10 to +10 actual °s
 - iv. If no external sensor is installed, EE will be displayed instead

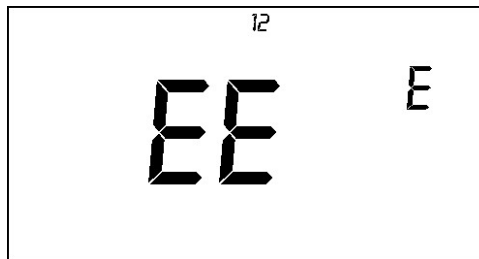
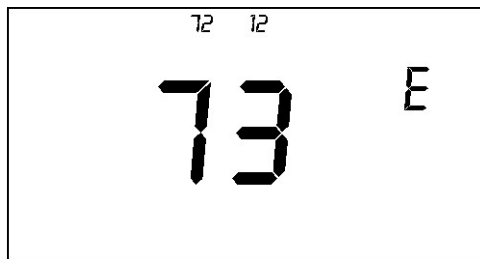

2) Press Program to exit calibration mode

Advanced 2-Stage Heating or Cooling Systems

INSTEON Wireless Thermostat does not have the ability to operate first or second stages of Heat or Cool directly but can instruct INSTEON Thermostat to operate the HVAC. First and second stage of Heat or Cool engages under the following conditions when INSTEON Thermostat is connected to the HVAC:

- INSTEON Thermostat setpoint is set at 5°(F or C) or more below ambient in Cool mode and 5°(F or C) or more above ambient in Heat mode
 - Heat mode setpoint is 80°, ambient is 72° = first and second stage engaged
 - Cool mode setpoint is 78°, ambient is 84° = first and second stage engaged
- INSTEON Thermostat has been active in Heat or Cool for longer than 10 minutes and did not reach setpoint
 - Heat mode ran for 10 minutes and did not reach setpoint = second stage engaged
 - Cool mode ran for 10 minutes and did not reach setpoint = second stage engaged

Note: It is possible for INSTEON Thermostat to occasionally engage and disengage second stage during a single heating or cooling cycle as variables are met.

Factory Reset

If you want to reset INSTEON Wireless Thermostat to its factory default settings, follow instructions below.

Note: If you choose to reset INSTEON Wireless Thermostat to its factory default settings, it is important that you remove scene memberships from all controllers. Otherwise, controllers will retry commands repetitively, creating network delays. Follow the instructions in Removing INSTEON Wireless Thermostat as an INSTEON Responder above for each scene controller of which INSTEON Wireless Thermostat is a member.

Factory reset changes:

- INSTEON is reset (all scene memberships are removed)
- Day/time is changed to 12:00PM
- Programming times, temperatures and other settings are reset to their default values

Factory reset does not change:

- Temperature offset
- Humidity offset

Factory Reset

- 1) Open INSTEON Wireless Thermostat and remove a battery
- 2) Wait 10 seconds
- 3) While pressing and holding the Set button, reinsert the removed battery. Do not let go of Set button.
Device will blink all segments and emit a long beep for about 10 seconds

- 4) When blinking/beeping stops, release Set button
*Device goes into factory reset for ~10 seconds and will perform a series of self tests
 Device will return to normal operations and display screen returns to normal*
- 5) If INSTEON Wireless Thermostat displays a two-digit error code instead of the ambient temperature, remove batteries, wait a few seconds, then reinstall
If problem persists, call INSTEON Support Line at 800-762-7845

Factory Reset Option 2

- 1) Press and hold INSTEON Wireless Thermostat Set button until it beeps
*INSTEON Wireless Thermostat will beep
 INSTEON Wireless Thermostat Set LED will blink green*
- 2) Press and hold INSTEON Wireless Thermostat Set button again until it beeps
*INSTEON Wireless Thermostat will beep
 INSTEON Wireless Thermostat Set LED will blink red
 LCD display indicates the group you are removing a scene from (default is Cooling)*
- 3) Double-tap Set button
- 4) Press and hold Set button again. Do not let go of Set button.
Device will blink all segments and emit a long beep
- 5) When blinking/beeping stops, release Set button
*Device goes into factory reset for about 10 seconds and will perform a series of self tests
 Device will return to normal operations and display screen returns to normal*
- 6) If INSTEON Wireless Thermostat displays a two-digit error code instead of the ambient temperature, remove batteries, wait a few seconds, then reinstall
If problem persists, call INSTEON Support Line at 800-762-7845



Specifications

General	
Product name	INSTEON Wireless Thermostat
Brand/manufacturer	INSTEON
Manufacturer product number	2441ZTH US/Can 2732-432 EU 2732-532 AUS/NZ
UPC	813922-010824 US/Can 813922-012873 EU 813922-012880 AUS/NZ
Warranty	2 years, limited
INSTEON	
INSTEON powerline mesh repeater	No
INSTEON RF mesh repeater	Yes (only if using external power supply)
INSTEON controller	Yes
INSTEON responder	No
Maximum links/scenes	400

LED	Dual-color, blinks red or green during setup	
LED brightness	N/A	
Local control	Yes	
Commands supported as controller	On	Off
Commands supported as responder	N/A	
Software configurable	Yes	
RF range	Up to 150-Feet (50m) open air	
Phase bridge detect beacon	No, RF-only device	
INSTEON device category	0x05 (all frequencies)	
INSTEON device subcategory	2441ZTH (915 MHz)	0x0A
	2732-432 (869 MHz)	0x11
	2732-532 (921 MHz)	0x12
X10		
X10 address	N/A	
X10 transmitter	N/A	
X10 receiver	N/A	
X10 status response	N/A	
X10 resume dim	N/A	
X10 minimum transmit level	N/A	
X10 minimum receive level	N/A	
X10 messages repeated	N/A	
Mechanical		
Mounting	Tabletop stand or wall-mount	
Wires	N/A	
Screw clamp connections	Yes, 4 position	
Case color	White	
Set button	1	
Plastic	UV stabilized ABS	
Beeper	Yes	
Beep on button press	Optional (off by default)	
LED	1 red/green dual-color	
Dimensions	5.7" x 3.6" x 1.3" (14.5cm x 9.1cm x 3.4cm)	
Weight	0.53 lbs, 8.4 oz, 240g (without batteries)	
Operating environment	Indoors	
Operating temperature range	4° to 40° C (39° to 104° F)	
Operating humidity range	0-90% relative humidity	
Storage temperature range	-20° to 70° C (-4° to 158° F)	
Electrical		

Battery	2 AA cells (quality alkaline recommended)
External Power Supply	4.5 to 7.5 volts DC, 200mA
Load type(s)	N/A
Maximum load	N/A
Minimum load	N/A
User replaceable fuse	No
Hardwired remote control	N/A
Retains all settings without power	Yes, saved in non-volatile EEPROM
Standby power consumption	22 micro-Amps (on battery power) 20mA (on external power, not in sleep mode)
Certifications	FCC ID Pat 15B & 15C and IC: RSS-210 Issue 8 (US/Can) ETSI EN 300 220-1 & 220-2, ETSI EN 301 489-1 & 489-3 (Eu) AS/NZ 4268 (C-Tick N16509)
FCC ID	SBP2441ZT
Marks	WEEE, RoHS (All models) C-Tick N16509 (Aus/NZ model)
Safety approval(s)	N/A, low voltage device

Troubleshooting

Problem	Possible cause	Solution
After powering up or a factory reset, INSTEON Wireless Thermostat displays a two-digit error code instead of the ambient temperature.	It didn't boot up fully.	Remove batteries from INSTEON Wireless Thermostat, wait a few seconds, then reinstall. If problem persists, call the INSTEON Support Line.
I replaced my INSTEON Wireless Thermostat with a new one, but now the INSTEON for Hub app doesn't recognize it.	The INSTEON for Hub app communicates via INSTEON I.D.s. They are still trying to communicate to the old thermostat's I.D.	Update the INSTEON I.D. on both the Hub and the INSTEON for Hub app with your new thermostat's I.D.
My INSTEON Wireless Thermostat temperature reading is taking a long time to update on my INSTEON Thermostat display.	At the top of each hour and, :15, :30, and :45 past, the INSTEON Wireless Thermostat will wake up and synchronize the readings with the INSTEON Thermostat display.	For an immediate update, press the temperature up or down button
INSTEON Wireless Thermostat's battery life seems very short.	Battery life depends on individual settings (such as LED backlight display on-time, notifying	Change INSTEON Wireless Thermostat settings to reduce battery consumption.

	software of all changes, etc.).	Use an AC adapter (sold separately) to power INSTEON Wireless Thermostat.
The displayed temperature and humidity don't seem accurate. When the Wireless thermostat is placed near the Wired Thermostat, the temperature and humidity readings are different.	Both units were calibrated at the factory prior to shipment. Other factors could contribute to different readings.	Use the Calibration feature to adjust either the temperature and humidity so the two unit match and the temperature feels about right.
When the power is removed, the clock settings are lost	The Wireless Thermostat does not have a back-up clock that keeps the time	If linked to an INSTEON Wired Thermostat, the Wireless Thermostat will pull the current time, temperature, and settings every 15 minutes.
When you change the Master mode from the INSTEON Wireless Thermostat to the INSTEON Thermostat, the Wireless Thermostat still reads master.	The Wireless Thermostat will wake up and synchronize data with the Wired Thermostat: <ul style="list-style-type: none"> • Every 15 minutes. • If it detects a temperature change. • If the up/down temperature buttons are pressed. 	During the synchronization, the "Master" icon will clear on the Wireless Thermostat.
When the Wireless Thermostat is linked to a Wired Thermostat, it will not directly control other linked devices based on temperature or humidity	This is normal.	Have your Wired Thermostat be the controller of other devices based on temperature and humidity.
When an AC adapter is used, the temperature and humidity settings are changing rapidly.	Noise from the AC adapter is affecting the Wireless Thermostat's electronics.	Be sure that your AC adapter is outputting between 5 to 7.5 volts.
		Change to a better quality AC adapter.
When I move the Wireless Thermostat to a cold room, the temperature does not update	The unit will update the display every minute. Also, the case and electronics of the unit will hold the warmth of the previous room for up to an hour.	After about one hour, the temperature display will stabilize and show an accurate figure.
	The air flow into the Wireless Thermostat may be blocked	Be sure to use the included stand or mount the unit on a wall to get good air flow.
The Wireless Thermostat will not go into Master Mode.	The Wired Thermostat only allows up to two Wireless Thermostats and will reject three or more.	Unlink the Wireless Thermostat(s) or reset all units and re-link.
The Wireless Thermostat or Wired Thermostat goes out of	The two units are too far from each other and unable to communicate with each other	Use INSTEON Range Extenders, Access Points, or Dual-Band modules between the two

Master Mode	and check in for updates. If the two units can't communicate, each will go out of the Master mode after 30 to 60 minutes	locations.
The temperature setpoints and the Mode changes from what it was set to.	The Wired Thermostat is the Master (or perhaps a different Wireless Thermostat) so the setpoint levels and mode changes (Heat, Cool, etc.) made at the Wired Thermostat (manually, following the Auto-schedule, or via another INSTEON controller) are being sent to the Wireless for display.	Press the Master button on the Wireless Thermostat so that it becomes the master and its mode and setpoints are controlling the Wired Thermostat.
Computer software or other controller can't retrieve the Wireless Thermostat's data (Temperature, Humidity, Setpoints).	When using only batteries, the Wireless Thermostat will go to sleep and not respond to signals from other INSTEON devices.	Add an AC adapter and the unit will stay on and awake all the time.
The Wireless Thermostat seems slow to update the sensed temperature and humidity.	The unit wakes up every minute and checks for changes. If differences are detected, the display is updated and communicated to linked devices.	Use an AC adapter for continuous temperature and humidity monitoring.

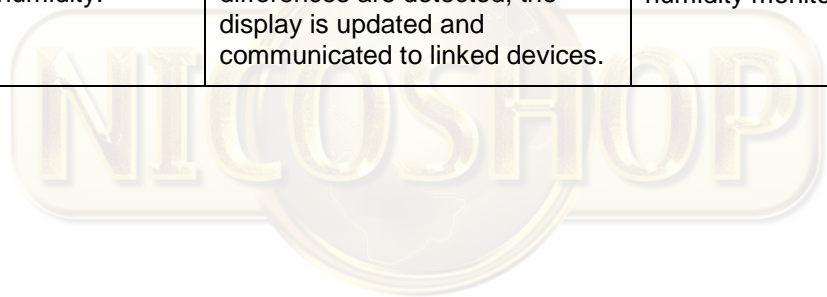

Certification and Warranty

FCC and Industry Canada Compliance Statement

This device complies with part 15 of the FCC Rules and Industry Canada license-exempt RSS-210. Operation is subject to the following two conditions:

- (1) This device may not cause harmful interference, and
- (2) This device must accept any interference, including interference that may cause undesired operation of the device.

Le présent appareil est conforme aux CNR d'Industrie Canada applicables aux appareils radio exempts de licence. L'exploitation est autorisée aux deux conditions suivantes:

- (1) l'appareil ne doit pas produire de brouillage, et
- (2) l'utilisateur de l'appareil doit accepter tout brouillage radioélectrique subi, même si le brouillage est susceptible d'en compromettre le fonctionnement.

The digital circuitry of this device has been tested and found to comply with the limits for a Class B digital device, pursuant to Part 15B of the FCC Rules. These limits are designed to provide reasonable protection against harmful interference in residential installations. This equipment generates, uses, and can radiate radio frequency energy and, if not installed and used in accordance with the instructions, may cause harmful interference to radio and television reception. However, there is no guarantee that interference will not occur in a particular installation. If this device does cause such interference, which can be verified by turning the device off and on, the user is encouraged to eliminate the interference by one or more of the following measures:

- Re-orient or relocate the receiving antenna of the device experiencing the interference
- Increase the distance between this device and the receiver
- Connect the device to an AC outlet on a circuit different from the one that supplies power to the receiver
- Consult the dealer or an experienced radio/TV technician

WARNING: Changes or modifications to this device not expressly approved by the party responsible for compliance could void the user's authority to operate the equipment.

DECLARATION OF CONFORMITY

Hereby, INSTEON declares that this device is in compliance with the essential requirements and other relevant provisions of the following Directives:

- 1) Electromagnetic Compatibility Directive 2004/108/EC**
- 2) Hazardous Substance Directive 2005/95/EC**

Technical data and copies of the original Declaration of Conformity are available and can be obtained from INSTEON; 16542 Millikan Ave, Irvine, CA, USA.

User Information for Consumer Products Covered by EU Directive 2002/96/EC on Waste Electric and Electronic Equipment (WEEE)

This document contains important information for users with regards to the proper disposal and recycling of INSTEON products. Consumers are required to comply with this notice for all electronic products bearing the following symbol:



Environmental Information for Customers in the European Union

European Directive 2002/96/EC requires that the equipment bearing this symbol on the product and/or its packaging must not be disposed of with unsorted municipal waste. The symbol indicates that this product should be disposed of separately from regular household waste streams.

It is your responsibility to dispose of this and other electric and electronic equipment via designated collection facilities appointed by the government or local authorities. Correct disposal and recycling will help prevent potential negative consequences to the environment and human health. For more detailed information about the disposal of your old equipment, please contact your local authorities, waste disposal service, or the shop where you purchased the product.

DECLARATION OF CONFORMITY TO R&TTE DIRECTIVE 1999/5/EC for the European Community, Switzerland, Norway, Iceland and Liechtenstein

Product category: general consumer (category 3).

English: This equipment is in compliance with the essential requirements and other relevant provisions of the European R&TTE Directive 1999/5/EC

Deutsch [German]: Dieses Gerät entspricht den grundlegenden Anforderungen und den weiteren entsprechenden Vorgaben der Richtlinie 1999/5/EU.

Nederlands [Dutch]: Dit apparaat voldoet aan de essentiële eisen en andere van toepassing zijnde bepalingen van de Richtlijn 1999/5/EC.

Svenska [Swedish]: Denna utrustning står i överensstämmelse med de väsentliga egenskapskrav och övriga relevanta bestämmelser som framgår av direktiv 1999/5/EG.

Français [French]: Cet appareil est conforme aux exigences essentielles et aux autres dispositions pertinentes de la Directive 1999/5/EC

Español [Spanish]: Este equipo cumple con los requisitos esenciales así como con otras disposiciones de la Directiva 1999/5/CE.

Português [Portuguese]: Este equipamento está em conformidade com os requisitos essenciais e outras provisões relevantes da Directiva 1999/5/EC.

Italiano [Italian]: Questo apparato é conforme ai requisiti essenziali ed agli altri principi sanciti dalla Direttiva 1999/5/CE.

Norsk [Norwegian]: Dette utstyret er i samsvar med de grunnleggende krav og andre relevante bestemmelser i EU-direktiv 1999/5/EF.

Suomi [Finnish]: Tämä laite täyttää direktiivin 1999/5/EY olennaiset vaatimukset ja on siinä asetettujen muiden laitetta koskevien määräysten mukainen.

Dansk [Danish]: Dette udstyr er i overensstemmelse med de væsentlige krav og andre relevante bestemmelser i Direktiv 1999/5/EF.

Polski [Polish]: Urządzenie jest zgodne z ogólnymi wymaganiami oraz szczególnymi warunkami określonymi Dyrektywą UE: 1999/5/EC

Limited Warranty

Seller warrants to the original consumer purchaser of this product that, for a period of two years from the date of purchase, this product will be free from defects in material and workmanship and will perform in substantial conformity to the description of the product in this Owner's Manual. This warranty shall not apply to defects or errors caused by misuse or neglect. If the product is found to be defective in material or workmanship, or if the product does not perform as warranted above during the warranty period, Seller will either repair it, replace it, or refund the purchase price, at its option, upon receipt of the product at the address below, postage prepaid, with proof of the date of purchase and an explanation of the defect or error. The repair, replacement, or refund that is provided for above shall be the full extent of Seller's liability with respect to this product. For repair or replacement during the warranty period, call the INSTEON Support Line at 866-243-8022 with the Model # and Revision # of the device to receive an RMA# and send the product, along with all other required materials to:

INSTEON
ATTN: Receiving
16542 Millikan Ave.
Irvine, CA 92606-5027

Limitations

The above warranty is in lieu of and Seller disclaims all other warranties, whether oral or written, express or implied, including any warranty or merchantability or fitness for a particular purpose. Any implied warranty, including any warranty of merchantability or fitness for a particular purpose, which may not be disclaimed or supplanted as provided above shall be limited to the two-year of the express warranty above. No other representation or claim of any nature by any person shall be binding upon Seller or modify the terms of the above warranty and disclaimer.

Home automation devices have the risk of failure to operate, incorrect operation, or electrical or mechanical tampering. For optimal use, manually verify the device state. Any home automation device should be viewed as a convenience, but not as a sole method for controlling your home.

In no event shall Seller be liable for special, incidental, consequential, or other damages resulting from possession or use of this device, including without limitation damage to property and, to the extent permitted by law, personal injury, even if Seller knew or should have known of the possibility of such damages. Some states do not allow limitations on how long an implied warranty lasts and/or the exclusion or limitation of damages, in which case the above limitations and/or exclusions may not apply to you. You may also have other legal rights that may vary from state to state.

Protected under U.S. and foreign patents (see www.insteon.com/patents)
© Copyright 2013 INSTEON, 16542 Millikan Ave., Irvine, CA 92606, 866-243-8022, www.insteon.com